

Configuration Manual

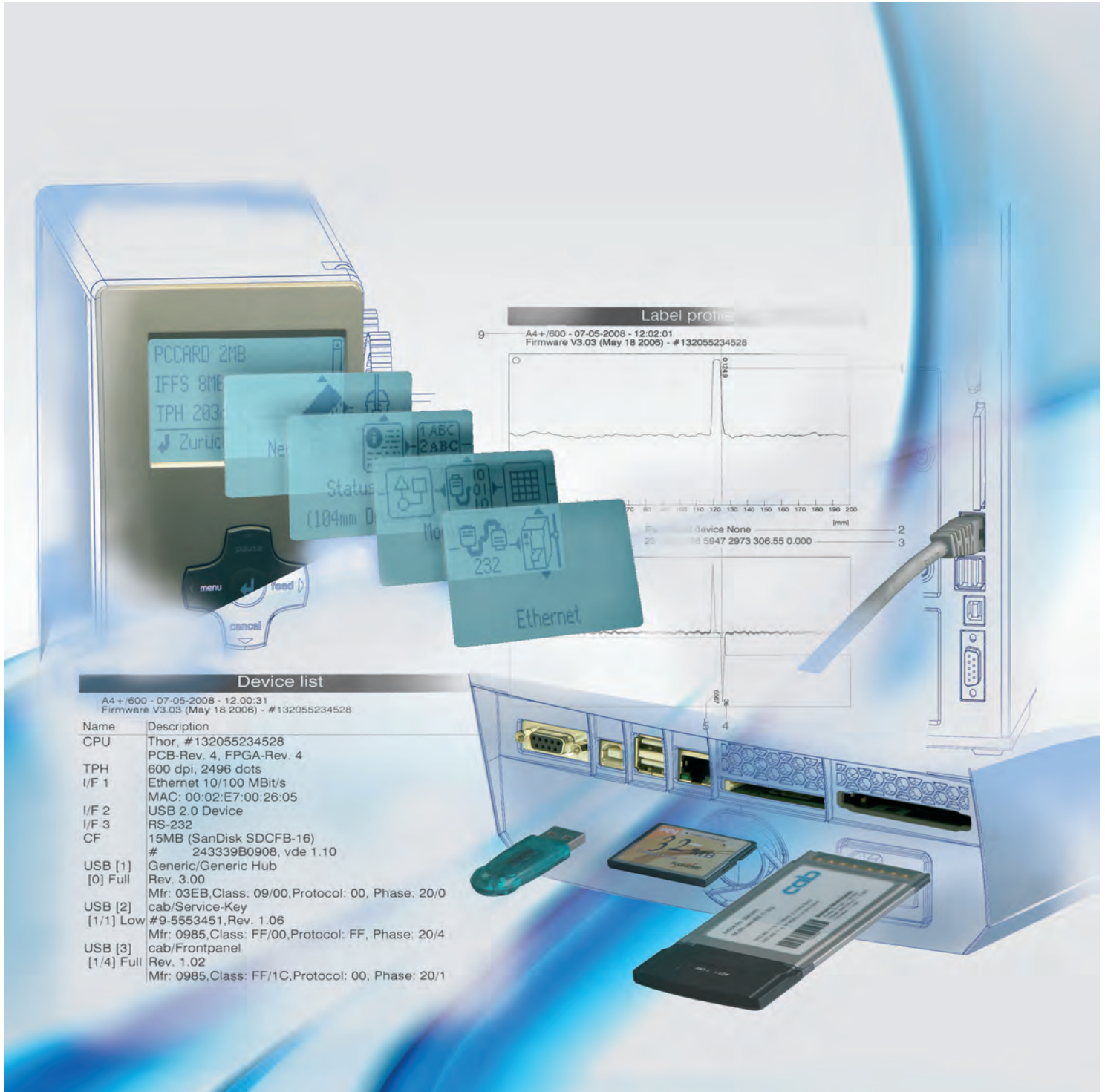

Device list

A4+/600 - 07-05-2008 - 12:00:31
Firmware V3.03 (May 18 2006) - #132055234528

Name	Description
CPU	Thor, #132055234528 PCB-Rev. 4, FPGA-Rev. 4
TPH	600 dpi, 2496 dots
I/F 1	Ethernet 10/100 MBit/s MAC: 00:02:E7:00:26:05
I/F 2	USB 2.0 Device
I/F 3	RS-232
CF	15MB (SanDisk SDCFB-16) # 243339B0908, vde 1.10
USB [1] [0] Full	Generic/Generic Hub Rev. 3.00 Mfr: 03EB,Class: 09/00,Protocol: 00, Phase: 20/0
USB [2] [1/1] Low	cab/Service-Key #9-5553451,Rev. 1.06 Mfr: 0985,Class: FF/00,Protocol: FF, Phase: 20/4
USB [3] [1/4] Full	cab/Frontpanel Rev. 1.02 Mfr: 0985,Class: FF/1C,Protocol: 00, Phase: 20/1

cab Label Printers

Made in Germany

Family	Type
A+	A2+, A4+, A4.3+, A6+, A8+, A4+M, A4+T
Hermes+	Hermes+ 2, Hermes+ 4, Hermes+ 6
Hermes C	Hermes C6
MACH4	MACH4, MACH4-24V, MACH4-RFID
PX	PX4, PX4.3, PX6
XC	XC4, XC6
XD	XD4M, XD4T

Edition: 09/2016 - Part No. 9008579

Copyright

This documentation as well as translation hereof are property of cab Produkttechnik GmbH & Co. KG.

The replication, conversion, duplication or divulgement of the whole manual or parts of it for other intentions than its original intended purpose demand the previous written authorization by cab.

Any software being part of this system is made available under license and may become use or be copied only in agreement with the license conditions.

Trademark

Microsoft® is a registered trademark of the Microsoft Corporation.

Windows is a registered trademarks of the Microsoft Corporation.

TrueType™ is a registered trademark of Apple Computer, Inc.

Centronics® is a registered trademark of the Data Computer Corporation.

Editor

Regarding questions or comments please contact cab Produkttechnik GmbH & Co. KG.

Topicality

Due to the constant further development of our products discrepancies between documentation and product can occur.

Please check www.cab.de for the latest update.

Terms and conditions

Deliveries and performances are effected under the "General conditions of sale of cab".

Germany

cab Produkttechnik
GmbH & Co KG
Postfach 1904
D-76007 Karlsruhe
Wilhelm-Schickard-Str. 14
D-76131 Karlsruhe
Phone +49 721 6626-0
Fax +49 721 6626-249
www.cab.de
info@cab.de

France

cab technologies s.a.r.l.
F-67350 Niedermodern
Phone +33 388 722 501
www.cab.de/fr
info.fr@cab.de

USA

cab Technology Inc.
Tyngsboro MA, 01879
Phone +1 978 649 0293
www.cab.de/us
info.us@cab.de

Asia 亚洲

cab Technology Co., Ltd.
希愛比科技股份有限公司
Junghe, Taipei, Taiwan
Phone +886 2 8227 3966
www.cab.de/tw
info.asia@cab.de

China 中国

cab (Shanghai) Trading Co., Ltd.
乾博(上海)贸易有限公司
Phone +86 21 6236-3161
www.cab.de/cn
info.cn@cab.de

Further partners on request

1	Introduction	5
1.1	Instructions	5
1.2	Intended Use	5
1.3	Safety Instructions.....	6
1.4	Environment.....	6
2	Connecting Label Printer to Computer	7
2.1	Connecting Label Printer via Serial RS-232 Interface.....	8
2.1.1	Connecting Label Printer.....	8
2.1.2	Pin Assignment of Connection Jack of the RS-232 Interface.....	8
2.2	Connecting Label Printer via Ethernet Interface	8
2.2.1	Print Services Raw-IP and LPD in MS Windows.....	9
2.2.2	Adjusting Windows Printer Setting	9
2.3	Connecting Label Printer via USB Interface.....	9
2.4	Connecting Label Printer via Optional Interfaces.....	10
3	Offline Menu	11
3.1	Structure of the Offline Menu	11
3.2	Navigating in the Offline Menu	12
3.3	Service Key	13
4	Configuration.....	14
4.1	Configuration via Operating Panel	14
4.1.1	Local Settings	14
4.1.2	Machine Parameters	15
4.1.3	Print Parameters.....	17
4.1.4	Interfaces.....	19
4.1.5	Status Line.....	20
4.1.6	Security.....	21
4.2	Configuration via the Printer Website.....	22
4.2.1	Calling up the Printer Website	22
4.2.2	Status Tab.....	22
4.2.3	Setup Tab	24
4.2.4	System Messages Tab	26
4.2.5	Printer Status Line Tab	27
4.2.6	Fonts Tab.....	28
4.2.7	Devices Tab.....	28
4.2.8	Help Tab	28
5	Test Functions	29
5.1	Overview	29
5.2	Short Status	29
5.3	Status Print.....	30
5.4	Font list.....	32
5.5	Device List.....	33
5.6	WiFi Status.....	34
5.7	ASCII Dump Mode	35
5.8	Test Grid.....	36
5.9	Label Profile	37
5.10	RFID Measurement.....	38
5.11	Event Log.....	39
6	Service Functions	40
6.1	Performing Firmware Update.....	40
6.1.1	Copying New Firmware via Interface.....	40
6.1.2	Copying New Firmware from Memory Medium	40
6.1.3	Error Messages during the Firmware Update.....	41
6.2	Clearing Service Counter	41
6.3	Adjusting Label Sensor	42
6.4	Save Settings	43
6.5	Load Settings	43
6.6	Changing OEM Name	43
6.7	Cleaning Interval	45

7	Pay-per-Print	46
7.1	Short Status PPP	46
7.2	Load PPP Voucher	46
7.2.1	Load PPP Voucher from Memory Medium	46
7.2.2	Load PPP Voucher via Interface.....	46
7.2.3	Load PPP Voucher via FTP	46
8	FTP Printer Management	47
8.1	FTP Logon	47
8.2	Directory Structure of the FTP Server.....	48
8.3	FTP Firmware Update.....	48
9	Memory Media	49
9.1	Suitable Memory Media	49
9.2	Installation	49
9.3	Formatting	49
9.4	Directory Structure	50
9.5	Writing	50
9.6	Memory Media Functions in the Offline Menu.....	51
9.6.1	Label from Card.....	51
9.6.2	Print Directory.....	51
9.6.3	Copy Memory Card	52
9.6.4	Format Card	53
9.6.5	ASCII Dump (Card)	53
10	External Keyboard	54
10.1	Connecting External Keyboard	54
10.2	Special Key Functions.....	54
10.3	Key Assignment and Special Characters	54
11	Index	57

1 Introduction

1.1 Instructions

Important information and instructions in this documentation are designated as follows:



Danger!

Draws attention to an exceptionally great, imminent danger to your health or life due to hazardous voltages.



Danger!

Draws attention to a danger with high risk which, if not avoided, may result in death or serious injury.



Warning!

Draws attention to a danger with medium risk which, if not avoided, may result in death or serious injury.



Caution!

Draws attention to a danger with low risk which, if not avoided, may result in minor or moderate injury.



Attention!

Draws attention to a danger with low risk which, if not avoided, may result in minor or moderate injury.



Note!

Advices to make work routine easier or on important steps to be carried out.



Environment!

Advices on protecting the environment.



Handling instructions



Reference to chapter, position, picture number or document.



Option (accessories, peripherals, extras).

Time Viewed in the display / monitor.

1.2 Intended Use

- The device is manufactured in accordance with the current technological status and the recognized safety rules. However, danger to the life and limb of the user or third parties and/or damage to the device and other tangible assets can arise during use.
- The device may only be used for its intended purpose and if it is in perfect working order, and it must be used with regard to safety and dangers as stated in the operating manual.
- The device printer is intended exclusively for printing suitable materials that have been approved by the manufacturer. Any other use or use going beyond this shall be regarded as improper use. The manufacturer/supplier shall not be liable for damage resulting from unauthorized use; the user shall bear the risk alone.
- Usage for the intended purpose also includes complying with the operating manual, including the manufacturer's maintenance recommendations and specifications.

1.3 Safety Instructions

- The device is configured for voltages of 100 to 240 V AC. It only has to be plugged into a grounded socket.
- Only connect the device to other devices which have a protective low voltage.
- Switch off all affected devices (computer, printer, accessories) before connecting or disconnecting.
- The device may only be used in a dry environment, do not expose it to moisture (sprays of water, mists, etc.).
- If the device is operated with the cover open, ensure that people's clothing, hair, jewelry etc. do not come into contact with the exposed rotating parts.
- The device or parts of it can become hot while printing. Do not touch during operation, and allow to cool down before changing material and before disassembly.
- Perform only those actions described in this manual.
Work going beyond this may only be performed by trained personnel or service technicians.
- Unauthorized interference with electronic modules or their software can cause malfunctions.
- Other unauthorized work on or modifications to the device can also endanger operational safety.
- Always have service work done in a qualified workshop, where the personnel have the technical knowledge and tools required to do the necessary work.
- There are various warning stickers on the device. They draw your attention to dangers.
Warning stickers must therefore not be removed, as then you and other people cannot be aware of dangers and may be injured.



Danger!

Danger to life and limb from power supply.

- ▶ **Do not open the device casing.**

1.4 Environment



Obsolete devices contain valuable recyclable materials that should be sent for recycling.

- ▶ Send to suitable collection points, separately from residual waste.

The modular construction of the printer enables it to be easily disassembled into its component parts.

- ▶ Send the parts for recycling.

The electronic circuit board of the device is equipped with a lithium battery.

- ▶ Take old batteries to collection boxes in shops or public waste disposal centers..

2 Connecting Label Printer to Computer

7

Choose from the following options for connecting a computer to the label printer:

- Direct connection to the serial RS-232 interface (1) (▷ 2.1 on page 8).
- Direct connection to the Ethernet interface (4) (▷ 2.2 on page 8).
- Connection via a computer network to the Ethernet interface (4) (▷ 2.2 on page 8).
- Direct connection to the high-speed USB slave interface (2) (▷ 2.3 on page 9).
- Connection via an optional interface adapter (Parallel/Centronics, RS-422/485) to a USB master interface (3).
- Connection to a wireless network via optional WLAN card installed in the slot for type II PC card.

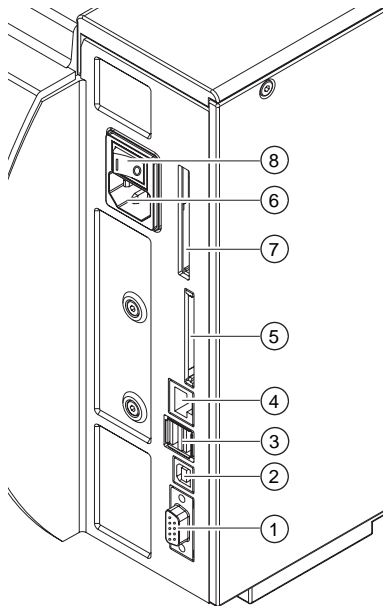

- 1 Serial RS-232 interface
- 2 USB 2.0 high speed slave interface
- 3 Two USB master interfaces for keyboard, scanner and optional interface adapters, USB flash drive or service key
- 4 Ethernet 10/100 Base T interface
- 5 Slot for CompactFlash memory card
- 6 Power connection jack
- 7 Slot for type II PC card or WLAN card
- 8 Power switch

Figure 1 Power and computer connections



Attention!

Insufficient or missing grounding can cause faults during operation.
Ensure that all computers and connection cables connected to the label printer are grounded.

2.1 Connecting Label Printer via Serial RS-232 Interface

2.1.1 Connecting Label Printer

The RS-232 interface is operated via an RS-232 cable.

- ▶ Connect computer and label printer with a suitable cable.
- ▶ Secure cable connections with the screws found at the plugs.
- ▶ Configure the RS-232 interface of the printer to match the settings of the connected computer (▷ 4.1.4 on page 19).

If problems occur, contact the computer manufacturer for interface assignments and note the pin assignment of the SUB-D jack described below.



Attention!

Loss of material at XC, XD and Hermes C !

The RS232 interface is unsuitable for fast transmission of changing data.

▷ Operator's Manual XC/XD/Hermes C.

Use USB or Ethernet interface for print operation at XC, XD and Hermes C.

2.1.2 Pin Assignment of Connection Jack of the RS-232 Interface

On the back of the printer there is a 9-pin SUB-D jack for the serial RS-232 interface.

	Pin	Designation	Function
	1	CD	Carrier Detect
	2	TxD	Transmit Data
	3	RxD	Receive Data
	4	DTR	Data Terminal Ready (not used)
	5	GND	Ground
	6	DSR	Data Set Ready (not used)
	7	RTS	Request to Send
	8	CTS	Clear to Send
	9	RI	Ring Indication (not used)

Table 1 Pin assignment of the 9-pin SUB-D jack

2.2 Connecting Label Printer via Ethernet Interface

To connect the label printer to a network jack, a patch cable with an RJ45 plug for 10 Base T or 100 Base T is required. For direct connection of the printer to the Ethernet card of a local computer, use an appropriate crossover cable.



Attention!

A shielded cable must be used to connect the printer to the network.

1. Connect computer and label printer with a suitable cable.
2. Make basic settings for operation of the Ethernet interface (▷ 4.1.4 on page 19).
3. Call up the printer website (▷ 4.2.1 on page 22).
4. Open the "Setup" tab on the printer website.
5. Set the parameters described in ▷ Table 11 on page 25 in the path `Setup > Interfaces > Ethernet`.
6. Click **Set** on the "Setup" tab (▷ 4.2.3 on page 24).
7. Enter PIN and click **Confirm**.
8. Set up print service if necessary (▷ 2.2.1 on page 9).
9. Adjust Windows printer setting (▷ 2.2.2 on page 9).



Attention!

Do not change the settings of the "IP" and "Gateway" on the printer website, as otherwise the connection to the printer may be lost.

2.2.1 Print Services Raw-IP and LPD in MS Windows

The print services Raw-IP and LPD are available in all current operating systems.

Information on installation ▷ Windows documentation.

During the installation of both print services, additional connections for print output are set up:

- ▶ Raw-IP: Enter the same port address in the printer which you have selected during installation.
- ▶ LPD: "lp" (line printer) must be entered as the name of the printer on the computer (queue name).

2.2.2 Adjusting Windows Printer Setting

If the printer driver valid for your Windows version is installed on your computer, Windows standard applications can be used to edit the label contents and to start the print jobs. To use the Raw-IP or LPD print services, the Windows printer settings must be adjusted:

1. Open the folder containing the printers via Start > Settings > Printers.
2. Right-click the icon of the label printer.
A pop-up menu appears.
3. Select "Properties" in the pop-up menu.
4. Open the "Details" or "Connections" tab.
This tab contains, among other things, the connections which were also set up when the print services were installed. The names of these connections depend on the installation tool used.
5. Select the Raw-IP or LPD connection.
6. Click **OK**.

2.3 Connecting Label Printer via USB Interface

The high-speed USB interface allows the label printer to be operated via a USB interface of a computer running one of the 32bit or 64bit operating systems:

- Windows Vista
- Windows 7
- Windows 8
- Windows 8.1
- Windows 10
- Windows Server 2003
- Windows Server 2008
- Windows Server 2008 R2
- Windows Server 2012
- Windows Server 2012 R2.

A printer driver must be installed if a USB interface will be used for connection. The printer driver for your unit is found on the "Installer DVD" which is included in the scope of delivery or on the internet.

1. Switch label printer off..
2. Connect computer and label printer with an A-B cable.
3. Switch computer on.
4. Place the "Installer DVD" in the DVD drive.
5. Exit all programs currently running.
6. Switch printer on.
The Windows Installation Wizard is started automatically.
7. Follow the on-screen instructions. After successful installation, an icon for the label printer appears in the Windows "Printer" system folder.
8. Click icon in "Printer" system folder and make printer settings if necessary.

2.4 Connecting Label Printer via Optional Interfaces

For the printer the following optional interfaces are available :

- Parallel/Centronics
- RS-422/-485
- WLAN card 802.11b/g

The Parallel/Centronics interface and the RS-422/-485 interface must be connected at a USB master interface of the printer. In order to install the WLAN card the slot for the PC card must be used.



Notice!

For detailed information see the Operating Instructions for the respective optional interface.

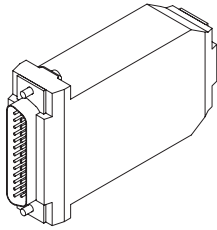

Parallel/Centronics

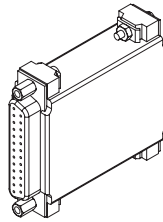

RS-422/-485

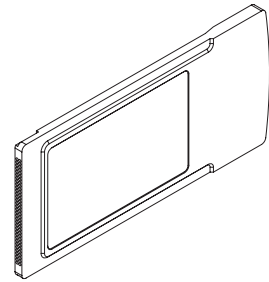

























WLAN Card

Figure 2 Optional Interfaces

3.1 Structure of the Offline Menu

The offline menu contains setting options on several levels for configuring the label printer. In addition, the offline menu features test functions for supporting the configuration or checking the function of the label printer. Using status functions, the set parameters can be displayed or printed.

1st menu level	2nd menu level	Access
 Memory card	 Label from card	* Only with memory medium inserted in the default card slot
	 Print directory	
	 Copy memory card	* Only with memory card or USB flash drive inserted, PIN protection possible
	 Format card	
	 ASCII dump (Card)	* Only with memory medium inserted in the default card slot
 Short status		
 Test	 Status print	
	 Font list	
	 Device list	
	 WiFi status	* Only with WLAN card installed
	 ASCII Dump mode	
	 Test grid	
	 Label profile	
	 RFID measurement	* Only at MACH4 with RFID unit
	 Event log	 Only with service key inserted
	 Setup	 Local setting
 Machine param.		
 Print param.		
 Interfaces		
 Status line		
 Security		















1st menu level	2nd menu level	Access
 Service	 Firmware upd.	PIN protection possible
	 Firmw. fr. card	* Only with memory medium inserted in the default card slot PIN protection possible
	 Clr. service ctr.	 Only with service key inserted
	 Adj. gap sensor	
	 Save settings	* Only with memory medium inserted in the default card slot PIN protection possible
	 Load settings	
	 OEM Name	 Only with service key inserted
	 Cleaning interval	PIN protection possible
 PPP™	 Short status PPP™	
	 Load PPP voucher	* Only with memory medium inserted in the default card slot PIN protection possible

Table 2 Menu structure

3.2 Navigating in the Offline Menu

All settings and functions in the offline menu can be controlled with the navigator pad.

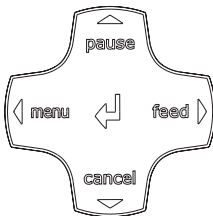

Figure 3 Navigator pad

Key	Menu	Parameter setting	
		Parameter choice	Numeric value
▲	Return from a submenu	-	Increase of the number at the cursor position
▼	Jump into a submenu	-	Decrease of the number at the cursor position
◀	Menu option to the left	Sheets to the left	Cursor shift to the left
▶	Menu option to the right	Sheets to the right	Cursor shift to the right
↵	Start of a selected menu option Pressing 2 s: Leaving the offline menu	Confirmation of the selected value Pressing 2 s: Abort without changing the value	

Table 3 Key function in the offline menu



Notice!

All settings in the offline menu also can be made via the Ethernet interface (▷ 4.2.3 on page 24) or via direct control commands (▷ Programming Manual).

3.3 Service Key

A service key is required for accessing special service functions not accessible to the operator. This key switches the printer to service mode and enables:

- Access to additional configuration parameters
- Adjustment of the label sensor
- Resetting of the service counter
- Additional information in the status print and in the device list
- Printout of an event list
- Changing of the device name
- Access to PIN-protected configuration parameters and functions without entering the PIN
- Access to configuration parameters for optional assemblies, even if they are not currently installed



Attention!

Incorrect settings and data loss via unauthorized access.

Access protection is deactivated when the service key is inserted. Operation of the printer by unauthorized persons can lead to incorrect settings and data loss in this case.

- ▶ **Provide the service key to authorized persons only.**
- ▶ **Remove service key after service work and store it in a secure location.**

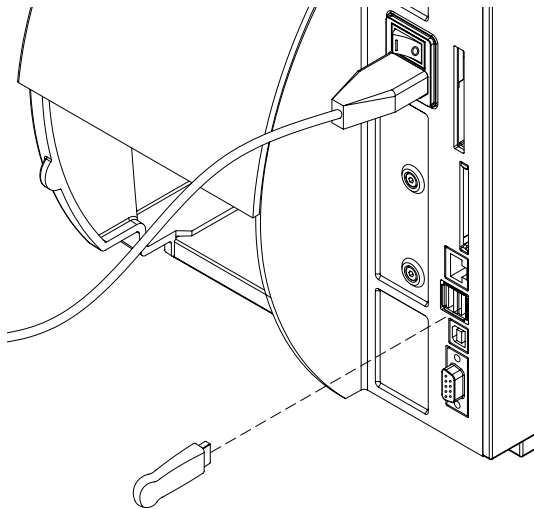

Figure 4 Inserting the service key

- ▶ Insert service key into a USB master interface on the back of the printer. The service key also can be inserted while the device is switched on.



Notice!

In this document, parameters and functions which are only accessible when the service key is inserted are indicated using the following note:



Access only when service key is inserted!

4.1 Configuration via Operating Panel

A host of parameters for configuring the printer are found in the `Setup` menu of the offline menu.

- ▶ Configure the printer via the operating panel during initial commissioning and when making major changes to the operational conditions.
- ▶ For changes required for processing different print jobs use software settings.



Notice!

The `Setup` menu can be protected from unauthorized access via a code number (PIN).

4.1.1 Local Settings

- ▶ Press the **menu** button.
- ▶ Select  Setup >  Local settings.























Parameter	Meaning	Default
 Country	Setting the display language and the country-specific date and time formats. The time formats can also be overwritten via software. The changes are not saved permanently, however.	UK
 Timezone	Adaptation of the time display of the printer to the time zone in relation to UTC (Universal Time Coordinated).	UTC+1
 Daylight saving	Selection of the daylight saving regulation applicable for the region. The time is then changed automatically.	EU
 Set date	Setting of the system date in the format DD.MM.YYYY (DD: day, MM: month, YYYY: year). The print output of the date occurs in the format set via the "Country" parameter. The date can also be changed via software. The change is not saved permanently, however.	-
 Set time	Setting the system time in the HH:MM:SS format. When changing the time, ensure that the Timezone, Daylight saving and Set date parameters are set correctly. The time can also be synchronized automatically via the internet using the Ethernet interface. The print output of the time occurs in the format set via the "Country" parameter. The time can also be changed via software. The change is not saved permanently, however.	-

Table 4 Parameters of the menu Setup > Local settings

4.1.2 Machine Parameters

- ▶ Press the **menu** button.
- ▶ Select  Setup >  Machine param..

Parameter	Meaning	Default
 Printhead pos. X	Shifting of the entire print image perpendicular to the direction of paper flow. The absolute shifting is limited by the margins of the print zone. Those are determined by the width of the printing line on the printhead. The <code>Printhead pos. X</code> can also be set via software. The offset values from the <code>Machine param.</code> menu and the software are added together.	0,0 mm
 Printhead pos. Y	Shifting of the entire print image in the direction of paper flow. With positive values, printing begins later in the direction of paper flow. Shifting of the print image in the direction of paper flow also influences the peel and cutting positions. ▶ Correct the <code>Peel position</code> and <code>Cut position</code> parameters by the same value in the opposite direction. The <code>Printhead pos. Y</code> can also be set via software. The offset values from the <code>Machine param.</code> menu and the software are added together.	0,0 mm
 Offset upper-lower head	at XC, XD and Hermes C only Shift the print image of the upper printhead in the direction of the media. With positive values, printing begins later in the direction of the media. The <code>Offset upper-lower head</code> can also be set via software. The offset values from the <code>Machine param.</code> menu and the software are added together.	0,0 mm
 Tear-off pos.	Shifting of the tear-off position in the direction of paper flow. With positive values, the label strip is transported farther out of the printer.	0,0 mm
 Demand sensor	Configuration of the peel-off parameters for devices with peel-off function.  If peel-off module is not installed, access only with service key inserted	
 > Peel position	Shift the position of the dispensed label relative to the dispensing edge. The <code>Peel position</code> can also be set via software. The offset values from the <code>Machine param.</code> menu and the software are added together.	0,0 mm
 > Backfeed delay	Delay time between removing the label from the peel position and the backfeed of the label.	250 ms
 > Limit peel-off spd.	Limitation of the print speed in the peel-off mode to 100 mm/s (203/300 dpi) respectively 50 mm/s (600 dpi)..	On
 Cutter	Configuration of the cut parameters for devices with cutter.  If cutter is not installed, access only with service key inserted	
 > Cut position	Offset of the cut position relative to the rear label edge. The <code>Cut position</code> can also be set via software. The offset values from the <code>Machine param.</code> menu and the software are added together.	0,0 mm
 > Cut depth	with perforation cutter only Setting of the perforation depth. The <code>Cut depth</code> can also be set via software. The offset values from the <code>Machine param.</code> menu and the software are added together.	0
 Applicator	at A+, Hermes+ and Hermes C only Configuration of the optional applicator. ▶ Operating instructions of the applicator  If applicator is not installed, access only with service key inserted	

































Parameter	Meaning	Default
 RFID	at MACH4 with RFID unit only Configuration of the RFID unit  If RFID unit is not installed, no access to the RFID parameters	
 > Void invalid labels	RFID labels with defective transponders are voided by block printing	Off
 > RFID error	Number of consecutive invalid RFID labels prior the operation is stopped and an error message is displayed	1
 > RFID power	Adaptation of the RFID power to the used labels	Standard
 I/O signals	at PX only Configuration of the input signals of the I/O interface	
 > Mode START	Configuration of the START signal Edge : A label will be printed by switching on 24V between START and GND_EXT. Level : In Rewind mode labels are printed as long as 24V are switched on between START and GND_EXT. In Peel-off mode a label will be printed after receiving the signal ETE as long as 24V are switched on between START and GND_EXT.	Edge
 > Mode WDR	Configuration of the WDR signal Edge : A label will be repeated by switching on 24V between WDR and GND_EXT. Level : A label will be repeated as long as 24V are switched on between WDR and GND_EXT. New/repeat : A label will be repeated when 24V are switched on between WDR and GND_EXT and the START signal will be activated additionally.	Edge
 Length correction	Correction of the print length in percent  Access only with service key inserted!	0,0%
 Sensor sensitivity	Reduction of the label sensor sensitivity  Access only with service key inserted!	0%
 Backfeed position	Offset of the backfeed movement	0,0 mm
 Brightness LCD	Brightness of the LCD display from 1 to 10.	10
 Contrast LCD	Contrast of the LCD display from 4 to 8.	6
 Time Powersave	Time between the last operation and activation of energy-saving mode.	Off
 Debug mode	Operating mode which supports the firmware programmer when localizing errors.	Off
 Orientation	Adaptation of the image positioning to the printer orientation Left handed, Right handed, Centered  Access only with service key inserted!	-
 Battery mode	at MACH4 only Setting the control to 24 V battery mode  Access only with service key inserted!	Off

Table 5 Parameters of the menu Setup > Machine param.

4.1.3 Print Parameters

- ▶ Press the **menu** button.
- ▶ Select  Setup >  Print param..

Parameter	Meaning	Default
 Heat level	<p>Heating value for compensating for the differing thermal behavior of printheads. Changing this value is then especially necessary if the printing intensity has changed after replacing the printhead.</p> <ul style="list-style-type: none"> ▶ To adapt the printing intensity when using different media, print speeds or printing contents, you should change the heat level in the software. <p>The settings from the <code>Print param.</code> menu and the software are added together.</p> <p>The <code>Heat level</code> setting also affects the test printouts.</p>	0
 Print speed	<p>Basic print speed setting.</p> <p>The print speed can be re-specified for each print job via software. The basic setting is not changed by this.</p> <p>The print speed setting also affects the test printouts.</p>	100 mm/s
 Transfer print	<p><code>On</code> for thermal transfer printing: Sensor for monitoring the transfer ribbon is activated.</p> <p><code>Off</code> for thermal direct printing: Sensor for monitoring the transfer ribbon is not activated.</p> <p>The setting can be overwritten for each print job via software. The basic setting is not changed by this.</p>	<code>On</code>
 Warn level ribbon	<p>Warning via the Ethernet interface by way of an SNMP message or e-mail sent when the remaining diameter of the ribbon supply roll undershoots the set value (32–74 mm).</p>	<code>Off</code>
 Ribbon saver	<p>at PX, XC, Hermes+ and Hermes C only</p> <p>JScript: Ribbon saver can be activated by the software</p> <ul style="list-style-type: none"> ▷ Programming Manual <p><code>On</code>: Ribbon saver is always active</p>	JScript
 Label sensor	<p>Method for detecting the starting end of the label.</p> <p><code>Gap Sensor</code>: Detection using changes in the transparency between the label and label gap.</p> <p><code>Bottom-Reflect</code>: Detection using reflex marks on the bottom of the medium.</p> <p>Continuous media:</p> <p> If cutter is not installed, access only with service key inserted!</p> <p>Synchronization of the paper flow when using endless media in cutting mode.</p> <ul style="list-style-type: none"> ▶ After loading media press the feed key. <p>That way a short feed and a synchronization cut are realized.</p>	Gap sensor
 Extrapolate pos.	<p>The positions of the labels which are between the label sensor and the printhead are calculated from the first label recognized by the sensor and the programmed label distance. That way those labels can be printed.</p> <p> Access only with service key inserted!</p>	<code>Off</code>
 Warn level labels	<p>Warning via the Ethernet interface by way of an SNMP message or e-mail sent when the remaining diameter of the label supply roll undershoots the set value (45–300 mm).</p>	<code>Off</code>













Parameter	Meaning	Default
 Tear-off mode	Positioning the label medium for tearing off at the tear-off plate. On: Additional advancement of the label medium which positions the label gap after the last printed label at the dispense plate. Off: Label advance stops once the last label has fully passed the print line.	Off
 Single label buffer	The next label will be processed when the current one has finished printing.	Off
 Backfeed	Method for backfeeding the label medium. Backfeeding is necessary in the cutting and peel-off modes since a label is pushed out passed the front edge of the next label above the print line when peeling off/cutting. always: Backfeeding occurs independently of label contents. smart: Backfeeding only occurs when the next label is not yet fully prepared when peeling off/cutting the current label. Otherwise, the second label is pushed on and completed after removal of the first label without backfeeding.	smart
 Backfeed	at PX only Printhead behavior during label backfeed. head lift-off: Printhead will be lifted away from the print roller head down: Printhead remains down on the print roller	head down
 Error-reprint	On: With a correctable error and corresponding troubleshooting, the label being printed when the error occurs is repeated. Off: Print job is continued with the next label.	On
 Pause reprint	Printing of another label with the information of the previous print job by pressing the pause button. This function can be executed until the print buffer is cleared with the cancel button.	Off
 Pause on media low	The printer switches to the Pause state when rest diameters set in the parameters Warn level ribbon or Warn lave labels are undershot.	Off
 Protocol error	On: Printer switches to Error mode when unknown or faulty data is received. Off: When working with older computer operating systems, it is possible that the print spooler of the operating system will reply to the printer with normal status messages of the printer (e.g. end of paper) in the form of ASCII text. The printer cannot interpret this data and outputs a large number of protocol errors. In this case, it is advantageous to set the Protocol error parameter to Off.  Attention! If the Protocol error parameter is set to Off, protocol errors which can be traced back to faulty programming are also ignored. There is a risk of data loss.  Access only when service key is inserted!	On
 Barcode error	On: With faulty barcode contents or size specifications, printing is interrupted. Off: Printing is not interrupted if an error occurs. If barcode contents are faulty, the printer attempts to replace the incorrect data with valid characters (e.g. zeros). If barcode size specifications are faulty, a gray area is printed instead of the barcode.	On
 Width ASCII dump	Width of the printing area in the ASCII Dump test function (> 5.7 on page 35). With the Automatic setting, the printout of the control sequences arriving at the printer occurs over the maximum printing width. The printing area width can be reduced down to 50 mm.	Automatic

Table 6 Parameters of the menu Setup > Print param.

4.1.4 Interfaces

- ▶ Press the **menu** button.
- ▶ Select  Setup >  Interfaces.























Parameter	Meaning	Default
 Default card slot	Definition of the default card slot. CompactFlash or PC-Card : card slots on the back of the printer, Ext. CompactFlash: card slot in the external operating panel, USB Memory: USB flash drive at USB master interface, IFFS: Internal Flash File System	Compact-Flash
 Character set	Selection of the character set table for adaptation to the computer system used. Switching the character set via software is not possible. Characters not available in the selected character set can be accessed using the Unicode table.	Windows 1252
 RS-232	Interface parameters for data transfer via the serial RS-232 interface.	
 > Baud rate	Speed (in Baud) of data transfer	57.600
 > Handshake	Data transfer protocol	RTS/CTS
 RS-422/485	Configuration of the optional serial RS-422 or RS-485 interface. ▶ Operating instructions of the interface.  If interface is not installed, access only with service key inserted	
 IEEE 1284	Configuration of the optional Parallel/Centronics interface. ▶ Operating instructions of the interface.  If interface is not installed, access only with service key inserted	
 Wireless LAN 802.11	Configuration of the optional WLAN card ▶ Operating instructions of the interface.  If interface is not installed, no access to the WLAN parameters	
 Ethernet	Configuration parameters of the Ethernet interface card Additional configuration parameters for the Ethernet interface can be accessed via the printer website (▶ 4.2.3 on page 24)  With WLAN card installed no access to the wired Ethernet interface !	
 > DHCP	Method of issuing IP address On: Dynamic issuing of IP address by the DHCP server Off: Direct issuing of the IP address by the operator	On
 > IP	IP address of the label printer. Only valid with DHCP = Off.	-
 > Mask	Subnet mask (classification and address range) of the local network. Only valid with DHCP = Off.	-
 > Gateway	Connection address between the local network and other networks. The IP address of the computer (router) on the network through which the connection can be established is used for this. The address of the router can also be issued via DHCP.	Off
 > Network error	Printer switches to Error mode when problems with the network connection occur.	Off
 Keyboard	Setting of the keyboard layout when using an external keyboard.  If keyboard is not connected, access only with service key inserted!	
 > Layout	Country setting of the keyboard layout. With the Automatic setting, the setting from the menu Local settings > Country is used..	Automatic
 > NumLock	Activation or deactivation of the numerical keypad on the keyboard.	On

Table 7 Parameters of the menu Setup > Interfaces

4.1.5 Status Line

Select the parameters (widget) to be displayed in Ready mode.

- ▶ Press the **menu** button.
- ▶ Select  Setup >  Status line.
- ▶ Activate the desired widgets.

**Notice!**

The display has a width 128 pixels. For that reasons it is not possible to display all widgets simultaneously. During the widget selection only those widgets are offered, which do not overflow the display. It may be necessary to remove widgets from the display before activating another one.

















Widget	Meaning	Default	Width [Pixel]
 Clock	Displays the current time.	On	32
 Date sheet	Displays the current calendar day.	On	20
 Date/time digital	Digital display of current date and time	Off	31
 Ribbon supply	Displays the current ribbon supply in the form of a horizontal bar.	Off	16
 WiFi signal strength	Displays the current strength of the electromagnetic field with a WLAN connection.	Off	14
 Ethernet link status	Displays the Ethernet status.	Off	13
 Temperature	Displays the current printhead temperature.	Off	8
 PPP funds	Displays the current "Pay Per Print" funds in the form of a horizontal bar. "Pay Per Print" is a method of paying for printer leasing by buying consumables from cab.	Off	15
 abc debug	Debug window for abc programs	Off	24
 abc window	The lower display line is controlled by an abc program	Off	128
 User space	Content of the user memory in the clock circuit (max. 31 byte)	Off	22
 Used memory	Displays the current memory used in the form of a vertical bar.	Off	15
 Input buffer	Displays the current input buffer used in the form of a vertical bar.	Off	11
 Battery state	at MACH4 - 24 V only: Displays the current charge state	Off	12
 RFID state	at MACH4 with RFID unit only : top left : amount of transponder blocks or E1 write error, E2 read error, E3 block locking error bottom left : bytes per block or error details right : transponder power	Off	24
 Card access	Icon displayed while an installed memory medium is being accessed.	On	8
 Data transfer	Displays the current data transfer in the form of a falling drop.	On	16

Table 8 Parameters of the menu Setup > Status line

4.1.6 Security

By activating a PIN, the *Setup* menu, certain memory medium functions and the firmware update can be protected from unauthorized access.

The protected menu items are then marked with the  symbol and are only accessible after the PIN is entered.

- ▶ Press the **menu** button.
- ▶ Select  Setup >  Security.



Parameter	Meaning	Default
 Security	Status of the PIN activation	Off
 PIN	Setting of the PIN	0000

Table 9 Parameters of the menu Setup > Security

4.2 Configuration via the Printer Website

The parameters accessible via the operating panel can also be set via the website contained in the firmware of the printer. In addition, other parameters for the Ethernet interface are accessible there.

The printer website can be accessed with a Java-capable browser (e.g. Microsoft Internet Explorer, Mozilla Firefox) via the Ethernet interface or the optional WLAN card. Use of the Java applets requires at least version 1.4.2 of Java.

4.2.1 Calling up the Printer Website



Attention!

It is absolutely necessary to define a PIN in order to make settings via the printer website. You are requested to enter this PIN whenever settings are changed via the website. The initial setting of the PIN can be made via the operating panel of the printer (▷ 4.1.6 on page 21) or via the printer website (▷ 4.2.3 on page 24).

- ▶ Start the browser.
- ▶ Call up printer website by entering the IP address via HTTP (e.g. http://192.168.100.208). The "Status" tab is open on the home screen.
- ▶ Check to see if the status "Ready" is displayed.

The printer website contains the following tabs:

- Status: general status description (▷ 4.2.2 on page 22).
- Setup: configuration parameter settings (▷ 4.2.3 on page 24).
- System messages: automatic sending of messages via e-mail (▷ 4.2.4 on page 26).
- Printer status line: printer status line layout (▷ 4.2.5 on page 27).
- Fonts: overview of the available fonts (▷ 4.2.6 on page 28).
- Devices: list of the hardware and optional components (▷ 4.2.7 on page 28).
- Help: online help (▷ 4.2.8 on page 28).

4.2.2 Status Tab

The screenshot shows the 'Status' tab of the printer website. At the top, there are navigation tabs: Status, Setup, System messages, Printer status line, Fonts, Devices, and Help. The main content area displays the following information:

cab A4+/300
 Firmware V3.37 (Jul 8 2014)
 Bootloader V1.19 (Mar 13 2008)

Temperature 26 °C (CPU 36 °C) Heat voltage 23.6 V
 Operative time 276h 27min Number of labels 718
 Thermal transfer 20.051m Thermal direct 8.873m

Printer info Ready

Date/Time	Description
04/12/2014/10:23:01	Setup
04/12/2014/10:22:26	+Memory card CompactFlash 31200 KByte
04/12/2014/10:22:23	Ready

At the bottom, there are buttons for 'Display', 'Reset', 'Print', and 'Update'.

Figure 5 "Status" tab on the printer website

The following information is contained in the top section of the "Status" tab:

- Printer type
- Firmware version
- Bootloader version
- Printhead temperature and temperature of CPU
- Heat voltage for the printhead.
- Operative time of the printer
- Number of labels printed since commissioning
- Previously printed paper length with thermal transfer printing
- Previously printed paper length with thermal direct printing
- Printer status: "Ready", "Printing label", "Settings" or "Error"



Notice!

Information is not updated automatically while the "Status" tab is open. Updating occurs when the tab is changed or by clicking the "Update" button.

A list of the events which have occurred since the printer was switched on are found in the bottom section of the tab. No more than the last eight events are displayed.

The "Ready" event provides information on when the printer was switched on.

The buttons on the bottom line of the "Status" tab have the following functions:

Button	Function
Display	<p>Opens a window which shows the current printer display.</p>  <p>The update interval (in s) can be set on the scale below the display. The display is not updated automatically with the "0" setting.</p>
Reset	<p>Hard : functions like switch-off and switch-on Soft : functions like the cancel key</p>
Print	<p>Opens the window for the settings of a local printer or network printer to be used to print the contents of the "Status" tab.</p>
Update	<p>Updates the display on the "Status" tab.</p>

Table 10 Buttons on the "Status" tab

4.2.3 Setup Tab

On the "Setup" tab all the configuration parameters can be set which are also accessible via the operating panel in the Setup menu. In addition, other parameters for the Ethernet interface or the WLAN card can be set (see below).

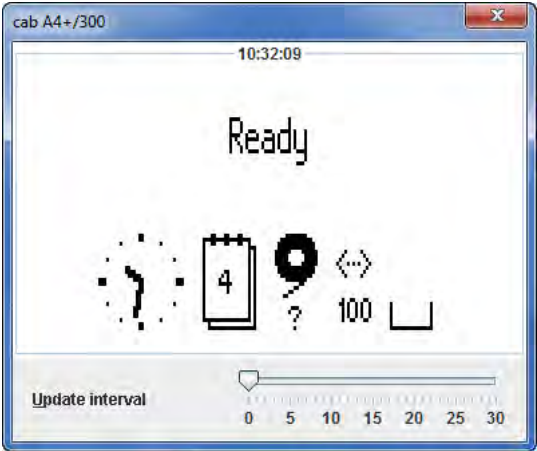
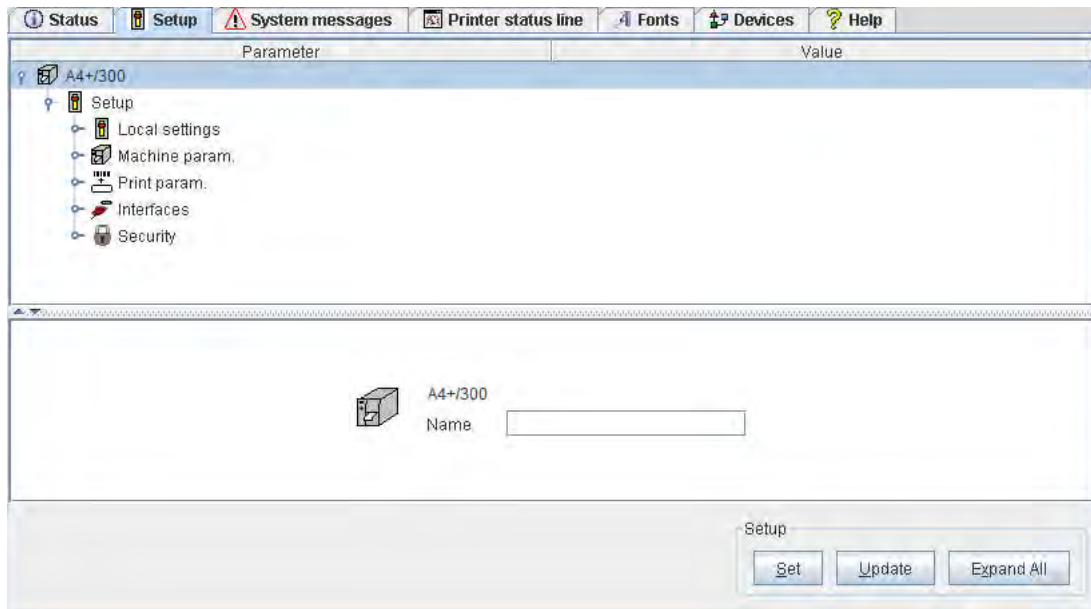

Figure 6 "Setup" tab on the printer website

The menus and parameters are arranged in a tree structure in the top section of the tab. The tree structure can be expanded in different ways:

- ▶ Click circular symbol in front of the menu symbol once.
The corresponding menu is expanded.
- ▶ Double-click menu symbol or menu name.
The corresponding menu is expanded
- ▶ Click the **Expand All** button.
The tree structure is fully expanded.

To change a parameter:

1. Locate parameter in the tree structure.
2. Click parameter name or the symbol next to it.
3. Enter value of the parameter in the input field in the bottom section of the tab.
4. Click **Set**.
5. Enter PIN and click **OK**.

The printer can be given a name on the top line of the tree structure. This name does not have a functional meaning. Its sole purpose is to allow the operator to more easily differentiate between the printers on a network.



Notice!

Information is not updated automatically while the "Setup" tab is open. Updating occurs when the tab is changed or by clicking the Update button.

The following parameters for the Ethernet interface can only be accessed via the printer website:

Parameter	Meaning	Default
SMTP server	E-mails can be sent to selected addresses when certain status and error messages are generated. To activate: <ul style="list-style-type: none"> ▶ Set parameter to "On". ▶ Enter IP address of the SMTP server. ▶ Enter a valid e-mail address for the printer in the "From address" field. More detailed information on sending e-mails ▷ 4.2.4 on page 26.	Off
Raw-IP port	Service for printing on the network (▷ 2.2.1 on page 9). <ul style="list-style-type: none"> ▶ Select a predefined port address. 	9100
LPD	Activation of the network printing service LPD (▷ 2.2.1 on page 9): <ul style="list-style-type: none"> ▶ Set parameter to "On". ▶ Typically activate the queue name "lp". Several print spoolers work without queue name. 	Off
LPD queue name	Activation of the LPD queue name	lp
SOAP	Activation of the protocol SOAP (Simple Object Access Protocol)	Off
SOAP password	Password setting for SOAP	Off
SNMP	Data exchange between printer and management station via SNMP (Simple Network Management Protocol). To activate: <ul style="list-style-type: none"> ▶ Set parameter to "On". ▶ Enter IP address of the management station(s) (receiver 1 or receiver 2). ▶ Assign the "Community" parameter the value "public". 	Off
Time server	Synchronization of the date and time of the printer. Notice: The time server functions with the TP protocol only To activate: <ul style="list-style-type: none"> ▶ Set parameter to "On". ▶ Enter IP address of the time server.. Synchronization occurs hourly. The accepted time is not automatically saved in the printer, however. To save the accepted time: <ul style="list-style-type: none"> ▶ Call up the parameter time and save the displayed setting with OK. 	Off
Anonymous FTP	Enables or disables a FTP-logon with as "Anonymous".	Off

Table 11 Additional parameters for Ethernet interface

4.2.4 System Messages Tab

Status and error messages can be sent automatically to the SNMP manager or via e-mail to the selected addresses immediately after they occur via the Ethernet interface or WLAN card. The messages to be sent and the destination addresses can be selected on the "System messages" tab.



Figure 7 "System messages" tab on the printer website

Column	Meaning
Description	Status and error messages that can be sent. <ul style="list-style-type: none"> ▶ Expand tree structure by clicking the circular symbol once or double-clicking the description. An entry for a higher-order description (e.g. note) is automatically accepted for all subordinate descriptions (e.g. "Start", "Not ready", "Ribbon running out").
SNMP 1 SNMP 2	Management stations on local network which communicate with the printer via SNMP. To make use of SNMP functionality, the SNMP agent must be activated (▷ 4.2.3 on page 24). <ul style="list-style-type: none"> ▶ Select management station by clicking the corresponding cell. The selection is indicated via a symbol. To undo the selection click it again.
E-mail	Valid e-mail address for the SMTP server to which the message is to be sent. <ul style="list-style-type: none"> ▶ Click cell and enter e-mail address or select from pull-down menu.
Sound	Audible signal which indicates receipt of the message. <ul style="list-style-type: none"> ▶ Click cell and select signal type in pull-down menu.

Table 12 Parameters on "System messages" tab

To change a parameter:

1. Locate the parameter in the tree structure.
2. Select the management stations or enter the e-mail address.
3. Select the sound.
4. Click **Set**.
5. Enter PIN and click **OK**.

4.2.5 Printer Status Line Tab

On the "Printer status line" tab, the status parameters (widgets) can be selected which are to be displayed on the printer status line.

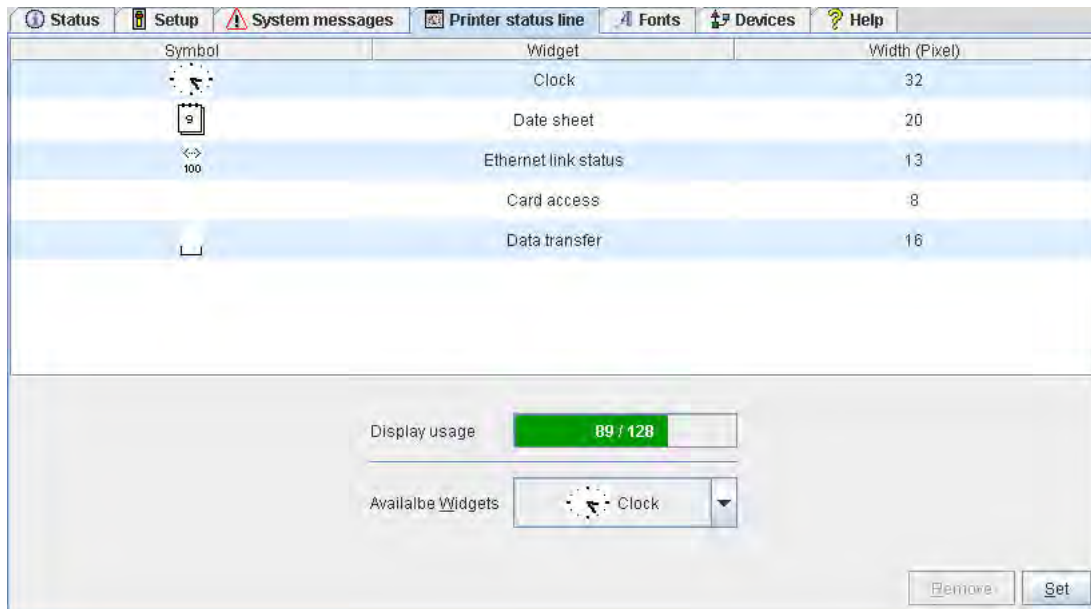

Figure 8 "Printer status line" tab on the printer website

The symbol, the parameter designation and the width of the symbol in the display (in pixels) are displayed in the top section of the tab. The entire width of all symbols in the display (e.g. 92 pixels) and the maximum width of the display (e.g. 128 pixels) are displayed in the "Display usage" field.

Adding a status parameter:

- ▶ Select widget in pull-down menu. Note the text color:
 - pale green : Widget may be added
 - pale red : Widget may only be added, if another widget is deleted
 - black : Widget is already activated
- ▶ Click **Set**.

Removing a status parameter:

- ▶ Select parameter in the top section of the tab.
- ▶ Click **Remove**.

4.2.6 Fonts Tab

The most important parameters of the fonts available in the printer are listed on the "Fonts" tab. The table contains both the original fonts in the printer and other fonts loaded into the printer.

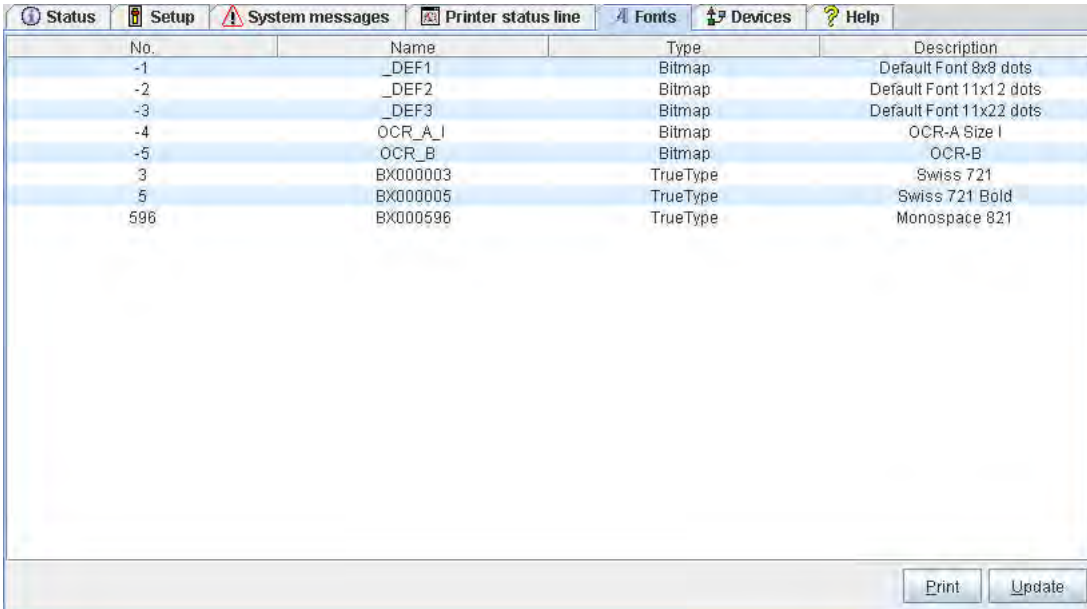

No.	Name	Type	Description
-1	_DEF1	Bitmap	Default Font 8x8 dots
-2	_DEF2	Bitmap	Default Font 11x12 dots
-3	_DEF3	Bitmap	Default Font 11x22 dots
-4	OCR_A_I	Bitmap	OCR-A Size I
-5	OCR_B	Bitmap	OCR-B
3	BX000003	TrueType	Swiss 721
5	BX000005	TrueType	Swiss 721 Bold
596	BX000596	TrueType	Monospace 821

Figure 9 "Fonts" tab on the printer website

The parameters correspond to those in the `Font list` and are described in ▷ Table 15 on page 32.

4.2.7 Devices Tab

The "Devices" tab provides an overview of the most important hardware components installed in the printer and the optional devices connected.

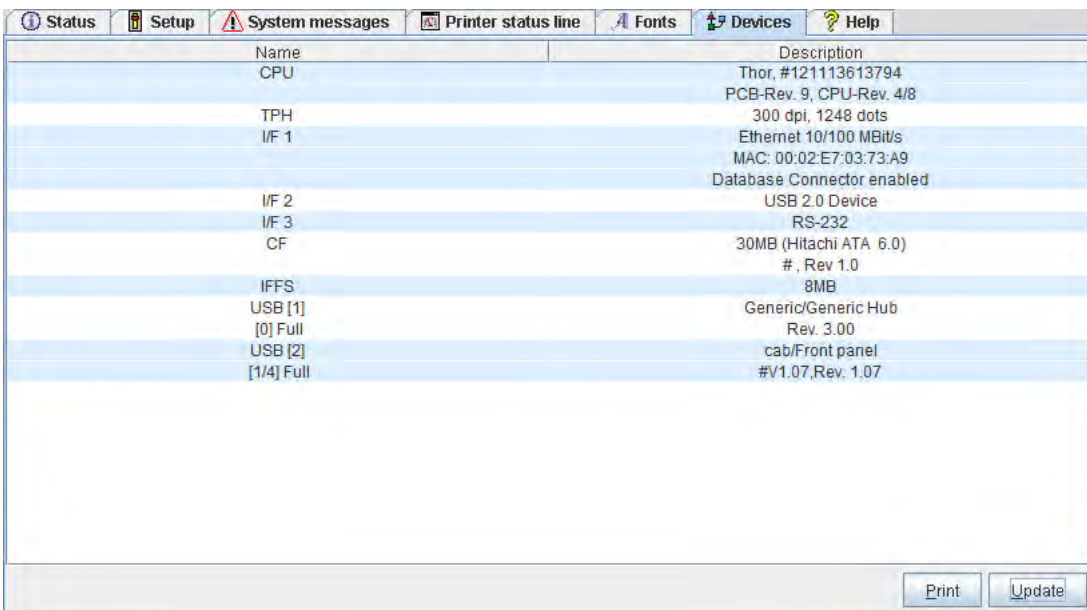

Name	Description
CPU	Thor, #121113613794 PCB-Rev. 9, CPU-Rev. 4/8
TPH	300 dpi, 1248 dots
I/F 1	Ethernet 10/100 MBit/s MAC: 00:02:E7:03:73:A9 Database Connector enabled
I/F 2	USB 2.0 Device
I/F 3	RS-232
CF	30MB (Hitachi ATA 6.0) #, Rev 1.0
IFFS	8MB
USB [1]	Generic/Generic Hub
[0] Full	Rev. 3.00
USB [2]	cab/Front panel
[1/4] Full	#V1.07, Rev. 1.07

Figure 10 "Devices" tab on the printer website

The contents correspond with those of the `Device list` and are described in ▷ Table 16 on page 33.

4.2.8 Help Tab

When the "Help" tab is selected, an internet connection to the support page of the cab website is opened.

5.1 Overview

The printer is equipped with different test functions providing information on:

- the most important configuration parameters
- the fonts available in the printer
- important hardware components and connected peripheral devices
- the print image quality and state of the thermal printhead
- the function of label detection in conjunction with the optical properties of the label medium
- the label data sent from the computer or read out from the memory medium

5.2 Short Status

The **i** Short status menu provides an overview of important status information in the display of the printer.

- ▶ Press the **menu** button.
- ▶ Select Short status menu.
- ▶ Scroll through the individual lines with the **▲** and **▼** buttons.
- ▶ Exit the Short status menu with the **↵** button.

The following configuration parameters are displayed in the Short status menu:

Line	Meaning	Example
1	Printer type	A4+/300
2	Version number of the printer operating system (firmware)	Firmware V3.37
3	Creation date of firmware	(Jul 8 2014)
4	Version number of the system loader (bootloader)	Bootloader 1.19
5	Creation date of the bootloader	(Mar 13 2008)
6	Serial number of the PCB CPU	PCB #121113613794
7	Revision of the CPU PCB and the CPU	PCB/CPU Rev. 9/4/8
8	Operative time and number of printed labels	Hours/no. of labels: 1156h/35648
9	Previously printed paper lengths with thermal direct printing / thermal transfer printing	Thermal/Transfer 13,54m/2069,11m
10	IP address of the label printer when connected to a network	DHCP-IP 192.168.9.21
11	mDNS name of the printer for Zeroconf (Zeroconf is a set of techniques that automatically create a usable IP network without configuration or special servers.)	mDNS: cab-73109.local
12	MAC address of the network adapter on the CPU PCB	MAC 0002E70373A9
13	Type and size of the installed memory medium	CF 30MB
14	Size of the Internal Flash-File-Systems (▷ Programming Manual)	IFFS 8MB
15	Resolution of the installed thermal printhead	TPH 300dpi,1248dots

Table 13 Display in Short status menu

5.3 Status Print

* Function not available at A2+ and Hermes+2 !

The  Status print function prints a test image containing information on the configuration and status of the printer. The printout occurs using the heat level and print speed specified in the Setup > Print param. menu.



Notice!

The printout occurs without taking the label gaps into consideration. This is why endless media are most suitable for this purpose.

- ▶ Insert printable medium (labels, endless paper) which extends across the entire printing width.
- ▶ If the printout is to occur using thermal transfer printing, insert transfer ribbon with the maximum width.
- ▶ Press the **menu** button.
- ▶ Select **Test > Status print**.
- ▶ Start printout with the **↵** button.

The printout can be cancelled with the **cancel** button.

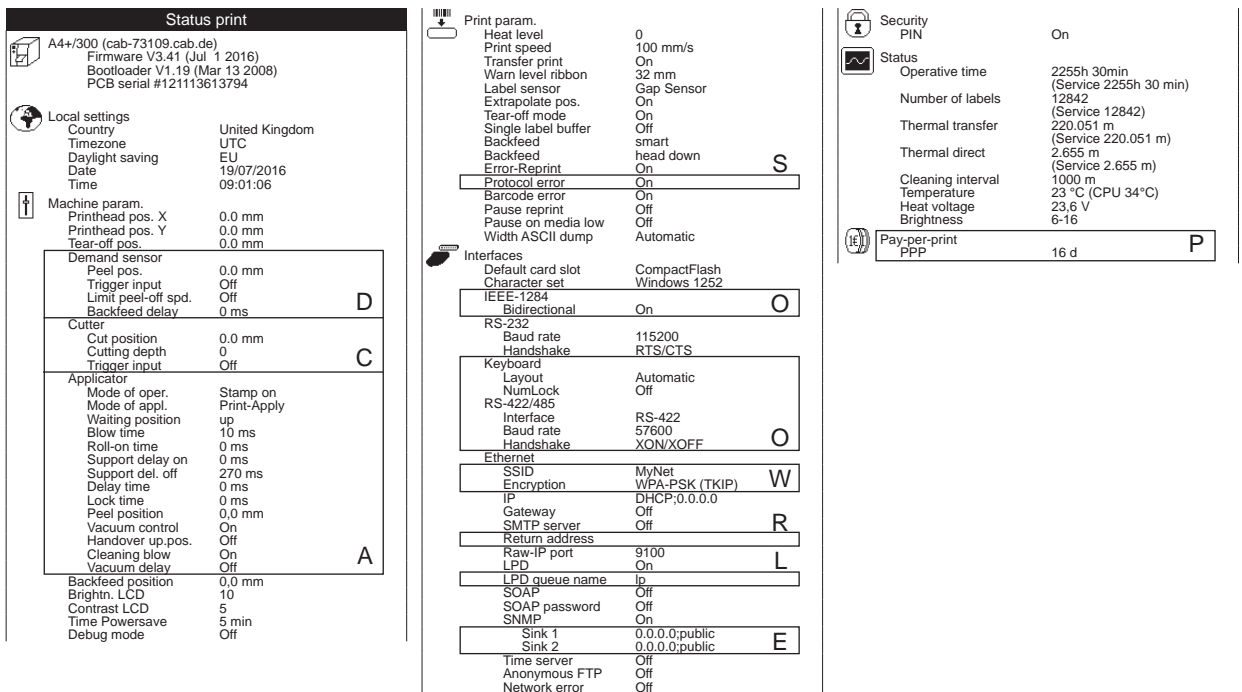

Figure 11 Status print

- A** displayed if an A+ printer is equipped with applicator or the service key is inserted
- C** displayed if the printer is equipped with cutter or the service key is inserted
- D** displayed if the printer is equipped with peel-off module or the service key is inserted
- E** displayed if SNMP is "On" or the service key is inserted
- L** displayed if LPD is "On" or the service key is inserted
- O** displayed if optional assemblies are installed or the service key is inserted
- P** displayed if the printer is operated in pay-per-print mode
- R** displayed if the SMTP server is "On" or the service key is inserted
- S** displayed when the service key is inserted
- W** displayed if the WLAN card is installed or the service key is inserted

The `Status print` contains the following information :









Symbol	Information
	<ul style="list-style-type: none"> • Device type and mDNS name of the printer for use in local networks without configuration • Version and creation date of the firmware • Version and creation date of the system loader (bootloader) • Serial number of the PCB CPU
	Current values of selected local settings (▷ 4.1.1 on page 14)
	Current values of selected machine parameters (▷ 4.1.2 on page 15).
	Current values of selected print parameters (▷ 4.1.3 on page 17).
	Current values of selected interface parameters (▷ 4.1.4 on page 19).
	Status of PIN activation (▷ 4.1.6 on page 21).
	<ul style="list-style-type: none"> • Operative time • Number of labels printed • Printed length with thermal transfer printing and thermal direct printing • Current measured values of the printhead temperature and heat voltage • Information on the working points of the label sensor
	Pay-per-print status (▷ 7.1 on page 46).

Table 14 Information in `Status print`

5.4 Font list

* Function not available at A2+ and Hermes+2 !

The  Font list function prints the most important parameters of the fonts available in the printer in tabular form. The table contains both the original fonts in the printer and other fonts loaded into the printer. The printout occurs using the heat level and print speed specified in the Setup > Print param. menu.



Notice!

The printout occurs without taking the label gaps into consideration. This is why endless media are most suitable for this purpose.

- ▶ Insert printable medium (labels, endless paper) which extends across the entire printing width.
- ▶ If the printout is to occur using thermal transfer printing, insert transfer ribbon with the maximum width.
- ▶ Press the **menu** button.
- ▶ Select Test > Font list print menu.
- ▶ Start printout with the **↵** button.

The printout can be cancelled with the **cancel** button.

Font list			
A4+/300 - 02/12/2014 - 13:19:59			
Firmware V3.37 (Jul 8 2014) - #121113613794			
No.	Name	Type	Description
-1	_DEF1	Bitmap	Default Font 12x12 dots
-2	_DEF2	Bitmap	Default Font 16x16 dots
-3	_DEF3	Bitmap	Default Font 16x32 dots
-4	OCR_A_I	Bitmap	OCR-A Size I
-5	OCR_B	Bitmap	OCR-B
3	BX000003	TrueType	Swiss 721
5	BX000005	TrueType	Swiss 721 Bold
596	BX000596	TrueType	Monospace 821

Figure 12 Font List

The parameters have the following meaning :

Column	Meaning
No.	ID number of the font required for programming (command T).
Name	Name with which the font is saved internally.
Type	Type of font generation. It provides information on the variability of the font and is important when programming (command T).
Description	Explanations of the font: size, font family. The printout occurs in the appropriate font.

Table 15 Parameters of the Font list

5.5 Device List

* Function not available at A2+ and Hermes+2 !

The  function prints out the most important information on hardware components of the printer and connected devices. The printout occurs using the heat level and print speed specified in the Setup > Print param. menu.



Notice!

The printout occurs without taking the label gaps into consideration. This is why endless media are most suitable for this purpose.

- ▶ Insert printable medium (labels, endless paper) which extends across the entire printing width.
- ▶ If the printout is to occur using thermal transfer printing, insert transfer ribbon with the maximum width.
- ▶ Press the **menu** button.
- ▶ Select Test > Device list print menu.
- ▶ Start printout with the  button.

The printout can be cancelled with the **cancel** button.

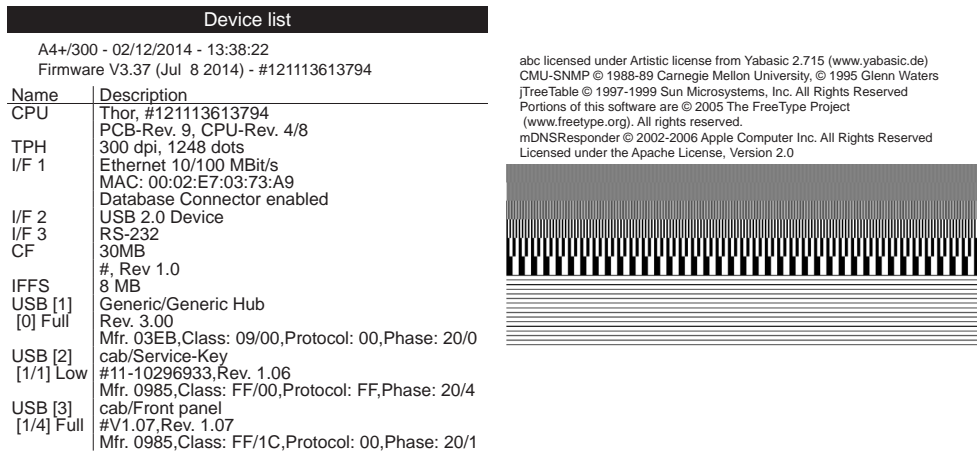



Figure 13 Device list

Name	Information
CPU	Type and serial number of the CPU PCB Revision of CPU PCB and CPU
TPH	Resolution and heating point number of the installed thermal printhead.
IF [x]	Type of interfaces installed x : Number of interface
IFFS	Size of the Internal Flash File System
CF / CFEXT / PCCARD / USBMEM	Size and type of an installed external memory medium
USB [a] [b/c] Speed	Type and revision of installed USB devices a : number of USB device b : number of USB device to which device a is connected c : number of interface of device b to which device a is connected Speed : data transfer speed (low, full, high) The following properties are only displayed when the service key is inserted: Mfr.: Manufacturer ID. This identifies the manufacturer of the USB device Class: Code for the USB device class Protocol: Code for the type of communication with the USB device Phase: Internal value for troubleshooting
Line pattern	Lines differing in thickness at various distances. They are used to evaluate the print quality.

Table 16 Parameters of the Device List

5.6 WiFi Status

- * Access only when a WLAN card is installed!
- * Function not available at A2+ and Hermes+2 !

The  `wifi status` function prints out a list the most important parameters of the accessible Wireless Access Points. The printout occurs using the heat level and print speed specified in the `Setup > Print param.` menu.



Notice!

The printout occurs without taking the label gaps into consideration. This is why endless media are most suitable for this purpose.

- ▶ Insert printable medium (labels, endless paper) which extends across the entire printing width.
- ▶ If the printout is to occur using thermal transfer printing, insert transfer ribbon with the maximum width.
- ▶ Press the **menu** button.
- ▶ Select `Test > WiFi status` print menu.
- ▶ Start printout with the `↵` button.

The printout can be cancelled with the **cancel** button.

WiFi status			
A4+/300 - 02/12/2014 - 15:21:00			
Firmware V3.37 (Jul 8 2014) - #121113613794			
Channel	Name/BSS ID	WiFi signal strength	Encryption
6	MyNet 00:11:6B:61:8D:C1	●●●●● 54,0 MBit/s	WPA-PSK (TKIP)
11	BT4233SA70 00:11:6B:61:AB:82	●●○○○ 54,0 MBit/s	WEP

Figure 14 WiFi status

The parameters have the following meaning :

Column	Meaning
Channel	Channel; frequency range of the Access Point
Name/BSS ID	Name of the wireless LAN MAC address of the Access Points
WiFi signal strength	Scale of the WiFi signal strength Data transfer rate
Encryption	Type of data encryption

Table 17 Parameters of the `wifi status`

5.7 ASCII Dump Mode

The  ASCII Dump Mode offers the option of checking incoming control sequences at the interface when working with direct programming. The incoming commands at the printer are printed out as text. In addition, a corresponding error message is printed out immediately after an error occurs.

The printout occurs using the heat level and print speed specified in the Setup > Print param. menu and is started after four lines are have been received.



Notice!

The printout occurs without taking the label gaps into consideration and without transfer ribbon checking. This is why endless media are most suitable for this purpose.

If only media (labels, endless paper) is available which do not cover the entire printing width, the width of the printout can continuously be reduced down to 50 mm with the width ASCII dump parameter (▷ 4.1.3 on page 17).



Notice!

In case of questions about programming, keep a printout of your label file which was created in ASCII Dump Mode handy. The printout can be transmitted clearly via fax.

- ▶ Load printable medium (labels, endless paper).
- ▶ If the printout is to occur using thermal transfer printing, insert transfer ribbon.
- ▶ If the printable medium and/or the transfer ribbon does not cover the entire printing width, reduce the width of the printout accordingly with the width ASCII dump parameter (▷ 4.1.3 on page 17).
- ▶ Press the **menu** button.
- ▶ Select Test > ASCII Dump Mode menu.
- ▶ Switch to ASCII dump mode with the **↵** button.
- ▶ Send print jobs.
- ▶ Call up the last few lines of a label description with the **feed** button.
- ▶ Press the **cancel** button to cancel the printout or switch to the Ready mode.

The control characters (ASCII code 00 to 31) are presented in the following form:

Code DEC HEX	Print- out	Code DEC HEX	Print- out	Code DEC HEX	Print- out	Code DEC HEX	Print- out
00 00	NUL	08 08	BS	16 10	DL _E	24 18	CA _N
01 01	SO _H	09 09	HT	17 11	DC ₁	25 19	EM
02 02	ST _X	10 0A	LF	18 12	DC ₂	26 1A	SU _B
03 03	ET _X	11 0B	VT	19 13	DC ₃	27 1B	ES _C
04 04	EO _T	12 0C	FF	20 14	DC ₄	28 1C	FS
05 05	EN _D	13 0D	CR	21 15	NA _K	29 1D	GS
06 06	AC _K	14 0E	SO	22 16	SY _N	30 1E	RS
07 07	BE _L	15 0F	SI	23 17	ET _B	31 1F	US

Figure 15 Presentation of the control characters in ASCII Dump Mode

Example:

In the following two figures, the printout in ASCII Dump mode is contrasted with the "normal" printout of a label.

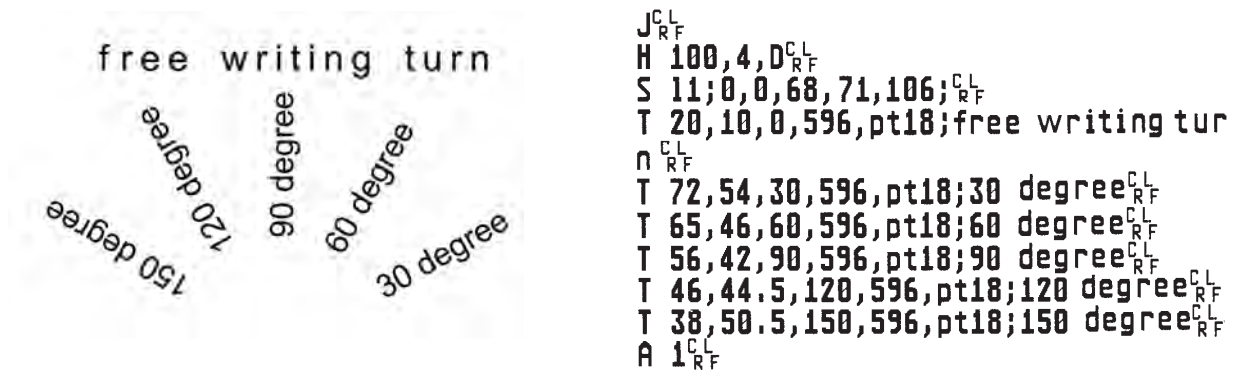

Figure 16 Example label printed normally (left) and in ASCII Dump Mode (right)

5.8 Test Grid

The  Test grid function prints out the geometric pattern on a background grid. This allows you to assess the evenness of the print quality.

The printout occurs using the heat level and print speed specified in the Setup > Print param. menu.

**Notice!**

The printout occurs without taking the label gaps into consideration. This is why endless media are most suitable for this purpose.

- ▶ Insert printable medium (labels, endless paper) which extends across the entire printing width.
- ▶ If the printout is to occur using thermal transfer printing, insert transfer ribbon with the maximum width.
- ▶ Press the **menu** button.
- ▶ Select Test > Test grid menu.
- ▶ Start printout with the **↵** button.

The geometric pattern is printed every 5 seconds once the Test grid function is started. During the pauses between the printouts the printer can be adjusted.

The printout of the test grid can be cancelled with the **cancel** button.

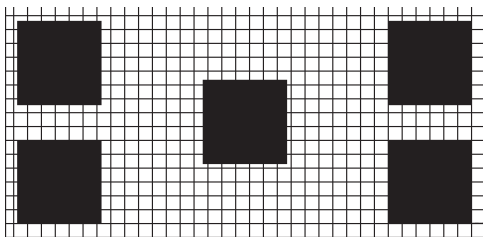



Figure 17 Example test grid

5.9 Label Profile

* Function not available at A2+ and Hermes+2 !

The  Label profile function carries out a longer label advance. It saves the values measured by the label sensor here and then prints them out in two diagrams. The printout is used to check label detection in conjunction with the optical properties of the label medium. The printout occurs using the heat level and print speed specified in the Setup > Print param. menu.



Notice!

The printout of the diagram occurs without taking the label gaps into consideration. This is why endless media are most suitable for the printout.

- ▶ Select the label sensor to be tested in the menu Setup > Print param. (▷ 4.1.3 on page 17).
- ▶ Load the label medium to be tested into the printer.
- ▶ Press the **menu** button.
- ▶ Select Test > Label profile print menu.
- ▶ Start the function with the **↵** button.
The printer performs a longer label advance. The label sensor measures the transparency/reflection capacity of the label material here. The message Test print OK appears in the display once the advance is complete.
- ▶ Insert printable medium (labels, endless paper) which extends across the entire printing width.
- ▶ If the printout is to occur using thermal transfer printing, insert transfer ribbon with the maximum width.
- ▶ Start the diagram printout with the **↵** button.

The following figure shows an example label profile. The top diagram shows the gradient determined for label detection. The rise (first derivative) of the gradient is represented in the bottom diagram. The starting end of the label is located at the point where the rise of the gradient exhibits a minimum (see vertical dotted line).

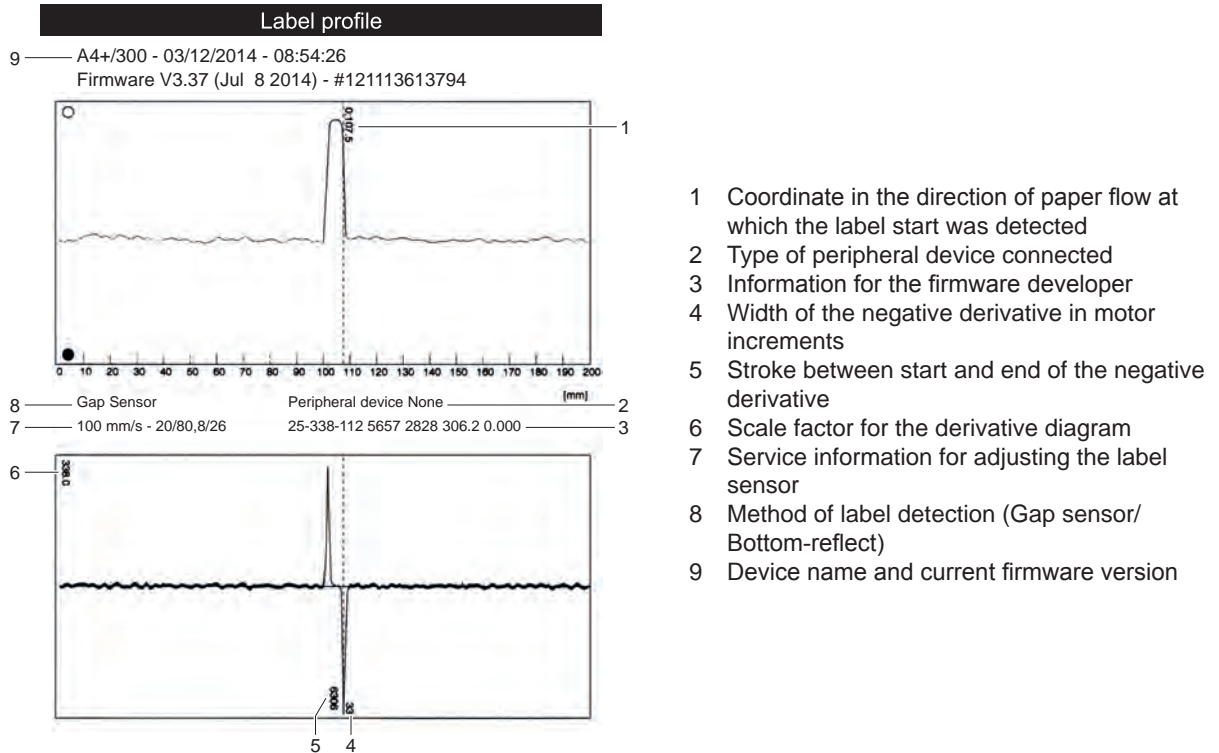



Figure 18 Label profile

5.10 RFID Measurement

* Access only at MACH4 with RFID read-write unit 13,56 MHz !

The  RFID measurement function allows to check the RFID power depending on the position of RFID labels during transport. It is used to find to best read/write position.

The printout occurs using the heat level and print speed specified in the Setup > Print param. menu.



Notice!

The printout of the diagram occurs without taking the label gaps into consideration. This is why endless media are most suitable for the printout.

- ▶ Select the RFID power to be used in the menu Setup > Machine param. > RFID power.
- ▶ Load the label medium to be tested into the printer.
- ▶ Press the **menu** button.
- ▶ Select Test > RFID measurement print menu.
- ▶ Start the function with the **↵** button.
The printer performs a short label advance and afterwards a number of backfeed steps. The printer measures the received signal power in every stop position. The message OK appears in the display once the measurement is complete.
- ▶ Insert printable medium (labels, endless paper) which extends across the entire printing width.
- ▶ If the printout is to occur using thermal transfer printing, insert transfer ribbon with the maximum width.
- ▶ Start the diagram printout with the **↵** button.

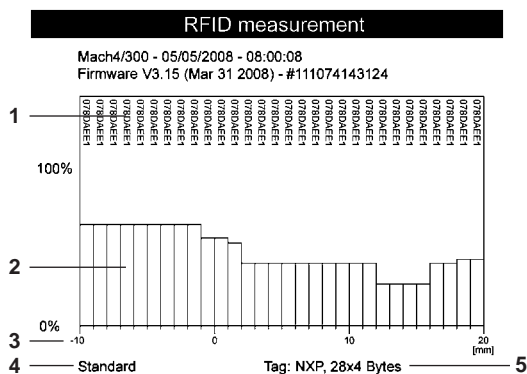

Figure 19 Fig. 19 RFID measurement

- 1 ID of the tested RFID tag
- 2 Signal power
- 3 Distance of the measuring position relative to the printing line
Use the position with the best reception in the command **E RFID** ▷ Programming Manual
- 4 Setting of the RFID power in the printer configuration
- 5 Manufacturer and memory size of the RFID tag

5.11 Event Log

* Function not available at A2+ and Hermes+2 !



Access only when service key is inserted!

The label printer saves the following events in the  Event log:

- Hardware fault
- Printhead replacement with a change in resolution
- Adjustment of the label sensor
- Firmware updates
- Resetting of the service counters

The printout occurs using the heat level and print speed specified in the Setup > Print param. menu.



Notice!

The printout occurs without taking the label gaps into consideration. This is why endless media are most suitable for this purpose.

- ▶ Insert service key into a USB master interface.
- ▶ Insert printable medium (labels, endless paper) which extends across the entire printing width.
- ▶ If the printout is to occur using thermal transfer printing, insert transfer ribbon with the maximum width.
- ▶ Press the **menu** button.
- ▶ Select Test > Event log print menu.
- ▶ Start printout with the  button.

Event log	
A4+/300 - 03/12/2014 - 14:17:30	
Firmware V3.37 (Jul 8 2014) - #121113613794	
Bootloader V1.19 (Mar 13 2008)	
Date/Time	Description
08.11.2011/11:18:55	Initialized (V3.28, Sep 23 2011)
08.11.2011/11:18:55	TPH -> 12dot/mm, 1280 dots
12.12.2011/12:48:47	TPH -> 12dot/mm, 1248 dots
12.12.2011/12:58:16	Adjust gap sensor: 6/16
23.01.2013/07:39:40	Firmware upd. (V3.31 Sep 19, 2012)
30.01.2013/07:35:41	Firmware upd. (V3.32 Jan 28, 2013)
01.12.2014/13:05:59	Firmware upd. (V3.37 May 13, 2014)

Figure 20 Event log

6.1 Performing Firmware Update

The firmware of the printer is saved in a Flash EPROM. An firmware update can be performed using the following functions:

- `Firmware upd.`: Copy a firmware file from a computer connected to one of the interfaces of a label printer (▷ 6.1.1 on page 40).
- `Firmw. fr. card`: Copy a firmware file from a memory medium (▷ 6.1.2 on page 40).
- FTP firmware update via printer management (▷ 8.3 on page 48).



Notice!

The firmware file can be obtained from the internet.

6.1.1 Copying New Firmware via Interface

1. Press the **menu** button.
2. Select `Service >`  `Firmware upd.` menu.
3. Press the `↵` button.
The `Firmware-Upd` message appears in the display.
4. Press the `↵` button.
5. If the function `Firmware upd.` is protected via a PIN, use the buttons `▲`, `▼`, `◀` and `▶` to enter the code number and confirm with the `↵` button.
6. Start the Windows command prompt on the PC.
7. Configure the serial interface of the PC with the mode command.
Example : **mode com1: baud=115200 parity=n data=8 stop=1**
8. Send the firmware file (e.g. `337_4708.x2`) to the printer.
Example : **copy /b 337_4708.x2 com1:**
A progress indicator is displayed while the firmware is being copied. `OK` appears in the display once copying is successfully completed.
9. Press the `↵` button.

6.1.2 Copying New Firmware from Memory Medium

1. Select in the menu `Setup > Interfaces > Default card slot` depending on the used memory medium `CompactFlash` or `USB Memory` (▷ 4.1.4 on page 19).
2. Format `CompactFlash` memory card or `USB flash drive` in the printer (▷ 9.6.4 on page 53).
The directories "fonts", "images", "labels" and "misc" are created on the memory medium here.
3. Copy the firmware file to the "misc" directory of the memory medium. This can be done on a computer or via FTP on the printer.
4. Insert the prepared memory medium into the printer.
5. Press the **menu** button.
6. Select `Service >`  `Firmw. fr. card` menu.
7. Press the `↵` button.
8. If the function `Firmw. fr. card` is protected via a PIN, use the buttons `▲`, `▼`, `◀` and `▶` to enter the code number and confirm with the `↵` button.
The names of the firmware files found on the memory medium are shown in the display.
9. If several firmware files are found on the memory medium, select the desired file with the `▲` and `▼` buttons.
10. Press the `↵` button.
The selected firmware file is copied. A progress indicator is displayed while the firmware is being copied. `OK` appears in the display once copying is successfully completed.
11. Press the `↵` button.

6.1.3 Error Messages during the Firmware Update

If an error occurs during the update, one of the following error codes is shown in the display:

Error code	Meaning
C	Checksum error. /b may have been forgotten in the COPY command or the file is defective.
H	Header error. /b may have been forgotten in the COPY command or the file is defective.
E	EPROM could not be cleared.
V	Programming voltage is too low.
P	Programming error.

Table 18 Possible error codes with a firmware update



Notice!

If an error occurs with a firmware update, the old firmware version is no longer usable.

► Restart programming.

6.2 Clearing Service Counter



Access only when service key is inserted!

The printer has total and service counters.

- Total counter: The total counter contains the values for the entire service life of the printer up to now. The values of the total counter are displayed in the *Short status* and in the *Status print*.
- Service counter: The service counter can be reset after more substantial maintenance or repair work with the service key inserted. Here, it provides information on the printing output since the last reset. The values of the service counter are displayed in the *Status print*.

The following data is recorded in both counters:

Data	Description
Operative time	Printer switch-on time
Number of labels	Number of labels printed
Transfer printing	Length of medium printed with transfer printing
Thermal printing	Length of medium printed with thermal direct printing

Table 19 Total and service counter data

1. Insert service key into a USB master interface.
2. Press the **menu** button.
3. Select *Service* > *Clr. service ctr. menu.*
4. Press the button.
No appears in the display.
5. Use the and buttons to select *Yes*.
6. Press the button.
The data recorded by the service counter is set to the value 0.

The status print can be used to check whether the values were reset. The service counter values are listed in parentheses under the total counter values there.

6.3 Adjusting Label Sensor



Access only when service key is inserted!

With the  Adj. gap sensor function label sensor can be adjusted in the see-through mode. This is necessary if sensor elements or CPU PCB has been changed.



Attention!

Close the print module and the cover after each loading or removal of material. This is required for a successful adjustment.

1. Insert service key into a USB master interface.
2. Press the **menu** button.
3. Select `Service > Adj. gap sensor` menu.
4. Press the `↵` button.
The display shows `Remove labels`.
5. Remove labels and transfer ribbon from the printer.
6. Press the `↵` button.
In the display the `Insert liner` message appears.
7. Load liner (without labels). Ensure that no labels are found on the liner near the sensor. Otherwise, the result will be faulty adjustment and device malfunction.
8. Press the `↵` button.
The message `Ribbon, no liner` is shown.
9. Remove liner, load transfer ribbon.
10. Press the `↵` button.
In the display the `Insert liner` message appears again.
11. Leave transfer ribbon in the printer, load liner additionally.
12. Press the `↵` button.
`OK` appears in the display after a successful adjustment.
13. Confirm completion of the adjustment with the `↵` button.

Other printers

1. Insert service key into a USB master interface.
2. Press the **menu** button.
3. Select `Service > Adj. gap sensor` menu.
4. Press the `↵` button.
The display shows `Remove labels`.
5. Remove labels from the printer.
6. Press the `↵` button.
In the display the `Insert liner` message appears.
7. Load liner (without labels). Ensure that no labels are found on the liner near the sensor. Otherwise, the result will be faulty adjustment and device malfunction.
8. Press the `↵` button.
`OK` appears in the display after a successful adjustment.
9. Confirm completion of the adjustment with the `↵` button.

Error during adjustment:

If an error occurs while adjusting the label sensor, Error appears in the display. If an error occurs again when repeating the adjustment, one of the following assemblies may be defective:

- Label sensor elements
- Connection cables of the label sensor
- CPU PCB

6.4 Save Settings

* Access only possible with memory medium in the default card slot!

With the  Save settings function the printer configuration can be saved to a memory medium (memory card, USB flash drive, Internal Flash File System) in the default card slot. The configuration will be saved as XML file in the folder \MISC of the CF card. The current date is used as file name YYYYMMDD.XML (e.g. 20141203.XML for a file saved on 12-03-2014).

1. Insert memory medium.
2. Press the **menu** button.
3. Select `Service > Save settings` menu.
4. If the function `Save settings` is protected via a PIN, use the buttons `▲`, `▼`, `◀` and `▶` to enter the code number and confirm with the `↵` button.
5. Saving of the configuration data starts. `OK` is shown in the display when the entire saving procedure is complete.
6. Press the `↵` button.
7. Do not remove the memory medium until the saving procedure is complete.

An error message appearing during the saving procedure may be caused by an unreadable medium (e.g. unknown card type, unformatted card) ▷ 9.3 on page 49.

6.5 Load Settings

* Access only possible with memory medium in the default card slot!

A printer configuration previously saved to a memory medium (memory card, USB flash drive, Internal Flash File System) can be loaded with the  Load settings function.

1. Insert memory medium.
2. Press the **menu** button.
3. Select `Service > Load settings` menu.
4. If the function `Load settings` is protected via a PIN, use the buttons `▲`, `▼`, `◀` and `▶` to enter the code number and confirm with the `↵` button.
5. If several configuration files are found on the memory medium, select the desired file with the `▲` and `▼` buttons.
6. Press the `↵` button.
Loading of the configuration data starts. Do not remove the memory card until the loading procedure is complete. `OK` is shown in the display when the entire loading procedure is complete.
7. Press the `↵` button.

If an error occurs during the loading procedure, an error message appears in the display. Restart the loading procedure in this case. If an error occurs again, the configuration parameters must be entered via the operating panel.

6.6 Changing OEM Name



Access only when service key is inserted!

With the  OEM Name function the firmware can be adapted to the device type.

1. Insert service key into a USB master interface.
2. Press the **menu** button.
3. Select `Service > OEM Name` menu.
4. Press the `↵` button.
A list of available names is shown in the display.
5. Use the `▲` and `▼` buttons to select the desired OEM name.
6. Press the `↵` button.

After replacement of the CPU X2 the parameters Service > OEM Name and Setup > Machine param. > Orientation possibly must be re-adjusted.

A+

Model	OEM Name	Orientation
A2+/300	cab A+/XL+/Mach	Left handed
A2+/600	cab A+/XL+/Mach	Left handed
A4+/200	cab A+/XL+/Mach	Left handed
A4+/300	cab A+/XL+/Mach	Left handed
A4+/600	cab A+/XL+/Mach	Left handed
A4.3+/200	cab A+/XL+/Mach	Left handed
A4.3+/300	cab A+/XL+/Mach	Left handed
A2+/300 K	cab A+/K	Left handed
A4+/200 K	cab A+/K	Left handed
A4+/300 K	cab A+/K	Left handed
A4+/600 K	cab A+/K	Left handed
A4+M/300	cab A+/K	Centered
A4+M/600	cab A+/K	Centered
A4+T/300	cab A+/XD/T	Centered
A4+T/600	cab A+/XD/T	Centered
A6+/200	cab A+/XL+/Mach	Left handed
A6+/300	cab A+/XL+/Mach	Left handed
A8+/300	cab A+/XL+/Mach	Left handed

Hermes+

Model	OEM Name	Orientation
Hermes+ 2L/300	cab Hermes+	Left handed
Hermes+ 2R/300	cab Hermes+	Right handed
Hermes+ 2L/600	cab Hermes+	Left handed
Hermes+ 2R/600	cab Hermes+	Right handed
Hermes+ 4L/200	cab Hermes+	Left handed
Hermes+ 4R/200	cab Hermes+	Right handed
Hermes+ 4L/300	cab Hermes+	Left handed
Hermes+ 4R/300	cab Hermes+	Right handed
Hermes+ 4L/600	cab Hermes+	Left handed
Hermes+ 4R/600	cab Hermes+	Right handed
Hermes+ 4.3L/200	cab Hermes+	Left handed
Hermes+ 4.3R/200	cab Hermes+	Right handed
Hermes+ 4.3L/300	cab Hermes+	Left handed
Hermes+ 4.3R/300	cab Hermes+	Right handed
Hermes+ 6L/200	cab Hermes+	Left handed
Hermes+ 6R/200	cab Hermes+	Right handed
Hermes+ 6L/300	cab Hermes+	Left handed
Hermes+ 6R/300	cab Hermes+	Right handed

Hermes C

Model	OEM Name	Orientation
Hermes C 6L/300	cab Hermes+	Left handed

MACH4

Model	OEM Name	Orientation
MACH4/200	cab A+/XL+/Mach	Centered
MACH4/300	cab A+/XL+/Mach	Centered
MACH4/600	cab A+/XL+/Mach	Centered

PX

Model	OEM Name	Orientation
PX4L/200	cab PX	Left handed
PX4R/200	cab PX	Right handed
PX4L/300	cab PX	Left handed
PX4R/300	cab PX	Right handed
PX4L/600	cab PX	Left handed
PX4R/600	cab PX	Right handed
PX4.3L/200	cab PX	Left handed
PX4.3R/200	cab PX	Right handed
PX4.3L/300	cab PX	Left handed
PX4.3R/300	cab PX	Right handed
PX6L/200	cab PX	Left handed
PX6R/200	cab PX	Right handed
PX6L/300	cab PX	Left handed
PX6R/300	cab PX	Right handed

XC

Model	OEM Name	Orientation
XC4/300	cab XC	Left handed
XC6/300	cab A+/XL+/Mach	Left handed

XD

Model	OEM Name	Orientation
XD4L/300	cab A+/XL+/Mach	Left handed
XD4M/300	cab A+/XL+/Mach	Centered
XD4T/300	cab A+/XD/T	Centered

Table 20 Setting of OEM Name and Orientation depending on the printer type

6.7 Cleaning Interval

The  Cleaning interval function is used for additional printhead maintenance control. The length of medium which passes the printhead can be selected in increments of 100 m after which the printhead is to be cleaned.

1. Press the **menu** button.
2. Select `Service > Cleaning interval` menu.
3. Press the `↵` button.
4. Select the desired value with the `◀` and `▶` buttons or select `Off` to deactivate the `Cleaning interval` function.
5. Press the `↵` button.

If the set length of the medium (label strip, transfer ribbon) has passed the printhead and an error occurs in the flow of the medium (e.g. label end, transfer ribbon end), the `Clean printhead!` message appears in the display. The error message for the error which occurred is not displayed until the `Clean printhead!` message is acknowledged. As long as no errors occur in the medium flow, no messages are displayed and the print job is continued even if the cleaning interval has passed.

PPP™ stands for „Pay-per-print“. cab established for distributors a secure internet portal, which can be used to transfer data for:

- pay-per-print leasing/rental services
- online-purchase of printer features (like database connector, asian fonts)
- online-purchase of services (e.g. unlocking printer PIN)

Typically for each transaction an encrypted data packet (voucher) of the **.ppp** type is created, which can be loaded to the printer with several methods (▷ 7.2 on page 46).

When purchasing asian fonts a **.x2** file is created. To load that file into the printer use the methods of the firmware update (▷ 6.1 on page 40).

7.1 Short Status PPP

The Short status PPP™ menu provides an overview of important PPP status information in the display of the printer.

- ▶ Press the **menu** button.
- ▶ Select `Short status PPP™`.
- ▶ Exit the Short status PPP™ menu with the `↵` button.

7.2 Load PPP Voucher

7.2.1 Load PPP Voucher from Memory Medium

1. Connect a CompactFlash card or an USB flash drive, which was formatted in printer, to a computer.
2. Copy the PPP voucher to the "misc" directory.
3. Set the parameter `Default card slot` matching to the used memory medium (▷ 4.1.4 on page 19).
4. Insert the prepared memory medium into the printer.
5. Press the **menu** button.
6. Select `PPP™ >  Load PPP voucher` menu.
7. If the function `Load PPP voucher` is protected via a PIN, use the buttons `▲`, `▼`, `◀` and `▶` to enter the code number and confirm with the `↵` button.
A list of available voucher names is shown in the display.
8. Use the `▲` and `▼` buttons to select the desired voucher.
9. Press the `↵` button.
`OK` appears in the display after a successful voucher loading.
If the selected voucher was not valid the message `ERROR` appears.
10. Press the `↵` button.

7.2.2 Load PPP Voucher via Interface

1. Start the Windows command prompt on the PC.
2. Configure the serial interface of the PC with the mode command.
Example: `mode com1: baud=115200 parity=n data=8 stop=1`
3. Send the PPP voucher file (e.g. `ppp_132062728086.ppp`) to the printer
Example: `copy /b ppp_132062728086.ppp com1:`
4. After a successful voucher loading a ring tone can be heard.

7.2.3 Load PPP Voucher via FTP

To load a PPP voucher, log on with the username "root" (▷ 8.1 on page 47).

1. Copy the PPP voucher to the „execute“ directory.
2. After a successful voucher loading a ring tone can be heard.

The File Transfer Protocol (FTP) allows to manage and transfer files on the network via the Ethernet interface or WLAN card. An FTP program (FTP client) is required which supports the "binary" transfer mode to manage the printer. The printer functions as an FTP server.

FTP printer management is comprised of four functions:

- management of the memory media installed in the label printer
- printer firmware update (▷ 8.3 on page 48)
- IFFS management
- direct printing via copying .LBL files

8.1 FTP Logon

To establish an FTP connection, the client must be logged on to the server. The logon type depends on the client. The following information must be specified in any case, however:

- IP address of the label printer
- User name and password

Access to the printer management functions depends on the user name:

User name	Password	Executable functions
anonymous	any	Display and download of the files stored on the memory media.
root	printer PIN	Display, upload and download of memory medium data, FTP firmware update, loading PPP vouchers. Label files loaded on the memory media must be of the .LBL type.

Table 21 Data for establishing an FTP connection

After logging on the FTP server is accessible in a manner similar to a Windows folder.



Attention!

It is absolutely necessary to define a PIN for FTP access with the username "root". The initial setting of the PIN can be made via the operating panel of the printer or via the printer website.

8.2 Directory Structure of the FTP Server

The files accessible via FTP are found in several folders:

Folder name	Contents
execute	Printing of label files stored in this folder is started immediately. The files must be of the type .LBL. The corresponding file is deleted once the print job is complete.
system	Firmware file of the printer
Display of the following folders depends on the installed memory media and the defined as the default card slot:	
card	Data of the memory medium in the default card slot. The structure of the folder depends on the medium type.
cf	Data of the CompactFlash memory card in the printer if the CF card slot is not default. The files are separated into several subfolders accordingly based on their type. When copying the files to the "cf" folder, type-based sorting occurs automatically in the subfolders.
cfext	Data of the CompactFlash memory card in the external operating panel if the external card slot is not default. The files are separated into several subfolders accordingly based on their type.
iffs	Contents of the IFFS (Internal Flash File System). When logging on with the username "root", the contents of the IFFS can be managed.
pccard	Data of the PC card if the card slot is not primary. This folder does not have a substructure.
usbmem	Data of the USB flash drive if the USB flash drive is not default. The files are separated into several subfolders accordingly based on their type. When copying the files to the "cf" folder, type-based sorting occurs automatically in the subfolders.

Table 22 Directory structure of the FTP server

8.3 FTP Firmware Update

To carry out a firmware update log on with the username "root" (▷ 8.1 on page 47).

1. Ensure that the label printer is in "Ready" mode (▷ 4.2.2 on page 22).
2. Set the "binary" transfer mode in the FTP client.
3. Open the "system" folder.
4. Copy a valid firmware file (e.g. 337_4708.x2) to the "system" folder.
FTP-Firmware-UPd appears in the display of the printer. The status of the saving procedure is shown by a progress indicator in the display. The printer resets automatically after the update is carried out successfully.

Whether the firmware update was carried out successfully can be checked on the "Status" tab of the printer website.

Graphics, fonts, label descriptions and database information can be saved for the long-term on memory media.



Notice!

- ▶ **Always create a backup copy of the memory card in case of a malfunction.**

9.1 Suitable Memory Media

External media

- Type 1 CompactFlash card in the corresponding card slot of the printer or in the external operating panel (cab accessory)
- PC card (PCMCIA) in the corresponding card slot of the printer
- USB flash drive at USB master interface

Internal medium

- approx. 5 MB flash memory inside the printer (Internal Flash File System)

9.2 Installation

* For external memory media only!

- ▶ Slide memory card contact-side first into the matching slot as far as it will go.
The rear section of the inserted memory card still extends from the device housing so that it can be removed by hand.
or
Connect USB flash drive to an USB master interface.



Notice!

When the memory cards are slid onto the contact pins, light physical resistance can be felt.

- ▶ Press the menu button.

Check whether the Memory card menu is shown in the display.

If the `Memory card` menu is not shown in the display, it could be because:

- the card slot being used is not selected as the default card slot
- the memory card is not inserted far enough into the card slot
- the memory card is entered incorrectly



Attention!

Do not remove a memory medium while it is being accessed. You can configure the printer so that access to a memory medium is indicated on the status line (▷ 4.1.5 on page 20).

9.3 Formatting

* For CompactFlash cards and PC cards only!

If the memory medium has not been pre-formatted in a suitable way, it can be formatted in the following manners:

- Formatting in the printer via the `Format card` menu item (▷ 9.6.4 on page 53).
- Formatting in the printer via the interface with the `Mf;name CR` command (▷ Programming Manual).

9.4 Directory Structure

On CompactFlash cards some folders are created during formatting.

On USB flash drives connected to the printer, the same directory structure is automatically generated when uploading files to the flash drive :

Folder name	Contents
fonts	Font files
images	Graphic files
labels	Label description files
misc	Firmware, PPP, Setup and TMP files

Table 23 Directory structure of CompactFlash cards and USB flash drives



Notice!

PC cards have no folders!

9.5 Writing

The memory medium can be written to in several ways. The most functionally secure way is writing to the card in the printer via a data interface.



Attention!

The medium in the default card slot is written to by default. To write to a medium in another slot specify the path name of the slot in the file name (▷ Programming Manual).

Example:

With direct programming, the command sequence for saving a label (file ABC) has the following form:

Ms LBL; ABC	Command for saving the file ABC
J	
H 100,0,T	
S l1;0,0,68,71,104	Contents of the file ABC
T 10,10,0,3,pt15;memory card	
A 1[NO PRINT]	
Ms LBL	End of save command

- After transfer of the command sequence, the file ABC is saved with the commands from J to A.
- Only one label is printed each time the file ABC is called up.
- The [NO PRINT] parameter in command A suppresses the printing of a label when the file is saved.
- To print the label a variable number of times, put command A after the ending Ms command.







9.6 Memory Media Functions in the Offline Menu

Accessing the `Memory card` menu is only possible if a memory medium is installed in the default card slot.

Only the medium in the default slot (> 4.1.4 on page 19) can be operated via the operating panel. When operating via an interface, each card slot can be addressed via a path.

9.6.1 Label from Card

Labels whose descriptions are saved on the memory medium can be printed using the  Label from card function.



1. Select the `Label from card` function in the `Memory card` menu.
2. Press the  button.
The name of the label found at the top of the index of the memory medium is displayed.
3. Select the desired label in the index of the medium with the  and  buttons.
4. Press the  button.
If a label is selected which was saved with a fixed label quantity, the print job is started immediately.
For label descriptions with a variable label quantity, a request to enter the label quantity  is displayed.
If additional input on the label description is required, the display requests to enter the variable data .
5. Enter the label quantity/variable data with the following buttons:
 - ◀ cursor left
 - ▶ cursor right
 - ▲ increase value at cursor position by 1 or select next letter in alphabet
 - ▼ decrease value at cursor position by 1 or select previous letter in alphabet
6. Press the  button briefly to confirm the input and start the print job.

Canceling input:

- ▶ Press and hold the  button at least 2 seconds.

9.6.2 Print Directory

You can print out the index of the installed memory card with the `Print directory` function.

1. Insert printable medium (labels, endless paper) which extends across the entire printing width.
2. If the printout is to occur using thermal transfer printing, insert transfer ribbon with the maximum width.
3. Press the **menu** button.
4. Select the  `Print directory` function in the `Memory card` menu.
5. Start printout with the  button.

The printout contains:

- the name of the memory medium
- information on the saved files
- the size of the available memory area

9.6.3 Copy Memory Card

* **For external memory media only!**

All the data from one memory medium can be copied to another one of the same type with the Copy memory card function. Copying between memory media with different memory capacities is possible. You can also use memory media which already contain data as a destination medium.



Attention!

Data loss when copying.

If files with the same name are found on the original and copy media, the files on the copy medium are overwritten without any prior notification. In addition, removal of the memory medium during the copying procedure leads to data loss.

► **Check files for the same name before copying.**

Only remove or insert memory media when so instructed in the display.

Unauthorized copying of memory media can be prevented by using a PIN (▷ 4.1.6 on page 21).

1. Insert original medium.
2. Press the **menu** button.
3. Select **Memory card** >  **Copy memory card** with the buttons **▶** and **◀**.
4. Press the **↵** button.
A selection field with the selection **No** appears in the display.
5. Use the **▲** and **▼** buttons to select **Yes**.
6. Press the **↵** button.
7. If the function **Copy memory card** is protected via a PIN, use the buttons **▲**, **▼**, **◀** and **▶** to enter the code number and confirm with the **↵** button.
The copying procedure starts. When copying larger amounts of data, the copying procedure is carried out in several copying cycles. An increasing progress indicator is shown in the display during a copy cycle. The **Insert dest.** instruction then appears.
8. Remove original medium and insert the medium to be written to.
The data read from the original medium is transferred to the copy medium. The progress indicator in the display shrinks during this process. If only part of the data from the original medium was read out, the **Insert source** instruction appears.
9. Remove copy medium and insert original medium again.
The next copy cycle begins.
10. Repeat the previous two steps until all data has been copied.
OK is shown in the display when the entire copying procedure is complete.
11. Press the **↵** button.

If the medium to be written to can no longer accept data during the copying procedure, the **Card full** error message appears in the display.

9.6.4 Format Card

* For external memory media only!

The  `Format card` function can be used to delete all data from a memory medium. This reformats the memory medium. This is why you can also use the `Format card` function if the `Unknown card` or `Structural err. error` message was output when using the medium.

Unauthorized deleting of memory medium can be prevented by using a PIN (▷ 4.1.6 on page 21).

1. Insert memory medium (▷ 9.2 on page 49).
2. Press the **menu** button.
3. Select `Memory card` > `Format card` with the buttons **▶** and **◀**.
4. Press the **↵** button.
A selection field with the selection `No` appears in the display.
5. Use the **▲** and **▼** buttons to select `Yes`.
6. Press the **↵** button.
7. If the function `Format card` is protected via a PIN, use the buttons **▲**, **▼**, **◀** and **▶** to enter the code number and confirm with the **↵** button.
The deleting procedure starts.
8. Do not remove the medium from the printer during the deleting procedure.
The memory volume of the medium is shown in the display as soon as the deleting procedure is complete.
9. Press any button.

9.6.5 ASCII Dump (Card)

The label files found on a memory medium consist of a sequence of printer commands. These command sequences can be printed in the form of text with the  `ASCII dump (Card)` function.

1. Insert printable medium (labels, endless paper) which extends across the entire printing width.
 2. If the printout is to occur using thermal transfer printing, insert transfer ribbon with the maximum width.
 3. Insert memory medium (▷ 9.2 on page 49).
 4. Press the **menu** button.
 5. Select the `ASCII dump (Card)` function in the `Memory card` menu.
 6. Press the **↵** button.
The index of the memory medium is shown in the display.
 7. Select the desired label file in the index of the medium with the **▲** and **▼** buttons.
 8. Start printout with the **↵** button.
The data printout is started after four lines are received. For this reason, it is often necessary to call up the last few lines of a label description with the **feed** button.
- The printout of the label description can be cancelled with the **cancel** button.

An external keyboard or a compatible input device (e.g. barcode scanner) can be connected directly to the printer. Using an external keyboard facilitates the entry of variable data while processing print jobs and printing from memory media.

Input prompts and the data received from the keyboard are shown in the display.

10.1 Connecting External Keyboard

Any MF-2-compatible USB keyboard which supports code set 3 can be connected to the printer.

- ▶ Insert connection cable of the keyboard into a USB master interface on the back of the printer.

10.2 Special Key Functions

General :

[F1]	Executes the <code>Label from card</code> memory media function.
[F2]	Prints an additional label from the last print job. Corresponds to the command A 1 CR .
[F3]	Repeats the last print job with renewed polling of the variable data and polling of the label quantity.
[F8]	Functions in the same manner as feed .
[Enter]	Switches to the offline menu. Functions in the same manner as menu .
[Esc]	Functions in the same manner as cancel .
[Space]	Functions in the same manner as pause . Not for continuing after an error.

Table 24 Special key functions: general

In the offline menu and for entry of variable data:

[←]	Moves cursor left. On the top level of the offline menu, switches back to <code>Ready</code> mode.
[→]	Moves cursor right.
[↑]	Increases the value at the cursor position.
[↓]	Decreases the value at the cursor position.
[Enter]	Confirms the input.
[Esc]	Cancels input and returns.

Table 25 Special key functions: offline menu and data input

10.3 Key Assignment and Special Characters

The printer features a specific keyboard assignment table for each setting of the `Country` configuration parameter. These tables generally match the DOS keyboard assignments (▶ 4.1.4 on page 19).

The [Alt Gr] key has no function. All special characters obtained using this key (e.g. [] { } \) and various other special characters (e.g. " × ÷) can be obtained using the [Alt] key. Additional special characters can be output using a sequence of two characters, whereby the [Alt] key must be pressed when entering the second character.

Some special characters cannot be shown in the display of the printer. In the case, they are replaced by a character similar to the special character.



Attention!

When using a scanner ensure that the same character set is set for both the scanner and the printer.

Country-specific special characters:

► Enter the following country-specific special characters with the [Alt] key pressed.

Zeichen	[Alt] + Taste											
€	E	E	E	E	E	E	E	E	E	E	E	E
{	7	'			ä	à	ç	7	8	'	7	B
}	0	=			\$	\$	à	0	9	ç	0	N
[8	(ü	è	^	8	è	`	8	F
]	9)			¨	¨	\$	9	+	+	9	G
\	ß	_			<	<	<	+		°	<	Q
	<	-	`		1	1	&	<		1	`	W
'									\	0		
'			'	`	'	'	ù					í
`		è					µ		'			ý
^		ç					§					š
˘	^	^	6	6	§	§	²	§	ì	<	½	;
¨				=
˜	+	é			^	^	=	¨	ù	4	¨	+
°			0	0				'	0	0		ř
²	2								2			
³	3								3			
#		"			3	3	"		à	3		X
\$								4			4	ů
¢					8	8						
£								3			3	
¤		\$										¨
@	q	à			2	2	é	2	ò	2	2	V
µ	m								m	m	m	
¬					6	6				6		
÷	/	/	/	/	/	/	/	/	/	/	/	/
×	*	*	*	*	*	*	*	*	*	*	*	*
	GR	FR	UK	US	SG	SF	BE	SU	IT	SP	DK	CZ

Zeichen	[Alt] + Taste
ˇ	č
ž	ž
·	á
”	é
˘	´
÷	ú
×)
ď	S
Đ	D
ł	K
Ł	L
ß	§
&	C
<	,
>	.
*	-
	CZ

Table 26 Country-specific special characters entered with the [Alt] key pressed

- | | | | | | |
|-----|----------------|-----|---------|-----|-----------------|
| GR: | Deutschland | SG: | Schweiz | IT: | Italia |
| FR: | France | SF: | Suisse | SP: | España |
| UK: | United Kingdom | BE: | Belgie | DK: | Danmark |
| US: | USA | SU: | Suomi | CZ: | Česka republika |

Characters between vertical lines (|/|, |*|) are entered with the corresponding keys on the numerical keypad of the keyboard.

Other special characters:

- To enter a special character in the ZZ column first enter the corresponding character in the Z1 column and then enter the character in the Z2 column while pressing the [Alt] button.

ZZ	Z1	Z2	ZZ	Z1	Z2	ZZ	Z1	Z2	ZZ	Z1	Z2
À	`	A	Ò	`	O	å	°	a	ò	`	o
Á	'	A	Ó	'	O	æ	a	e	ó	'	o
Â	^	A	Ô	^	O	a	_	a	ô	^	o
Ã	~	A	Õ	~	O	ç	,	c	õ	~	o
Ä	¨	A	Ö	¨	O	ç		c	ö	¨	o
Å	°	A	Ø	/	O	č	ˇ	c	ø	/	o
Æ	A	E	Œ	O	E	d'	'	d	œ	o	e
Ç	,	C	Ř	ˇ	R	è	`	e	°	_	o
Č	ˇ	C	Š	ˇ	S	é	'	e	í	'	r
D'	'	D	Ù	`	U	ê	^	e	ř	ˇ	r
È	`	E	Ú	'	U	ë	¨	e	š	ˇ	s
É	'	E	Û	^	U	ě	ˇ	e	ß	s	s
Ê	^	E	Ü	¨	U	ì	`	i	ţ	'	t
Ë	¨	E	Ý	'	Y	í	'	i	ù	`	u
Ì	`	I	¥	-	Y	î	^	i	ú	'	u
Í	'	I	Ž	ˇ	Z	ï	¨	i	û	^	u
Î	^	I	à	`	a	ij	i	j	ü	¨	u
Ï	¨	I	á	'	a	l'	'	l	ú	°	u
IJ	I	J	â	^	a	í	'	l	ý	'	y
£	-	L	ã	~	a	ñ	~	n	ÿ	¨	y
Ñ	~	N	ä	¨	a	ň	ˇ	n	ž	ˇ	z

Table 27 Special characters entered via a sequence of two characters

Example:

Entering the character: ñ 1st entry: [~] 2. entry: [Alt] + [n]

**Notice!**

- If necessary, use the information in ► Table 26 on page 55 to enter the character Z1.

- A**
- Activating a PIN..... 21, 22
 - Adjust gap sensor..... 12, 42
 - ASCII dump (Card)..... 11, 53
 - ASCII dump mode..... 11, 35
 - Ausrichtung..... 44
- B**
- Backfeed..... 18
 - Backfeed delay..... 15
 - Backfeed position..... 16
 - Barcode error..... 18
 - Battery mode..... 16
 - Battery state..... 20
 - Baud rate..... 19
 - Bootloader version..... 23, 29, 31
 - Brightness LCD..... 16
- C**
- Character set..... 19
 - Cleaning interval..... 12, 45
 - Clear service counter..... 12, 41
 - CompactFlash..... 7, 19, 33, 48, 49
 - Contrast LCD..... 16
 - Control characters..... 35
 - Copy memory card..... 11, 52
 - Country..... 14
 - Cut position..... 15
 - Cutter..... 15
- D**
- Daylight saving..... 14
 - Debug mode..... 16
 - Default card slot..... 19
 - Demand sensor..... 15
 - Device list..... 11, 33
 - Devices tab..... 28
 - DHCP..... 19
 - Direct programming..... 35
- E**
- Environment..... 6
 - Error-Reprint..... 18
 - Ethernet..... 19
 - Ethernet interface..... 7, 8
 - Event log..... 11, 39
 - Extrapolate position..... 17
- F**
- Firmware update..... 12, 40
 - from memory card..... 12, 40
 - via FTP..... 48
 - via interface..... 40
 - Firmware version..... 23, 31
 - Font list..... 11, 32
 - Fonts tab..... 28
 - Format card..... 11, 53
 - FTP..... 47
 - FTP logon..... 47
 - FTP server..... 48
- G**
- Gateway..... 19
- H**
- Handshake..... 19
 - Heat level..... 17
 - Help tab..... 28
- I**
- IEEE 1284..... 19
 - IFFS..... 19, 48
 - Intended use..... 5
 - Interfaces..... 11
 - IP..... 19
- K**
- Key assignment..... 54
 - Keyboard..... 19, 54
 - Key functions..... 54
- L**
- Label from card..... 11, 51
 - Label profile..... 11, 37
 - Label sensor..... 17
 - Length correction..... 16
 - Limit peel-off speed..... 15
 - Load PPP voucher..... 12, 46
 - Load settings..... 12, 43
 - Local settings..... 11, 14
 - LPD..... 9
- M**
- Machine parameters..... 11, 15
 - Mask..... 19
 - Memory media..... 49
 - ASCII dump..... 53
 - directory structure..... 50
 - format card..... 53
 - installation..... 49
 - label from card..... 51
 - print directory..... 51
 - writing..... 50
- N**
- Network error..... 19
 - NumLock..... 19
- O**
- OEM name..... 12, 43, 44

Offline menu 11
 memory media functions..... 51
 navigating 12
 structure 11
 Operative time 31
 Orientation 16, 44

P

Parallel/Centronics interface..... 7, 10
 Pause on media low 18
 Pause reprint 18
 Pay per print
 loading voucher 46
 short status 46
 PC card..... 7, 19, 33, 48, 49
 Peel position 15
 PIN..... 21
 Print directory 11, 51
 Printer status line tab 27
 Printer website 22
 Printhead position X 15
 Printhead position Y 15
 Printing intensity 17
 Print parameters 11, 17
 Print services 9
 Print speed 17
 Protocol error 18

R

Raw-IP 9
 RFID
 measurement 38
 parameter 16
 power 16, 38
 state 20
 Ribbon saver 17
 RS-232 interface..... 7, 19
 RS-422/-485 interface 7, 10, 19

S

Safety instructions 6
 Save settings 12, 43
 Security..... 11, 21
 Serial interface..... 7
 Service counter..... 12
 Service key 13
 Set date 14
 Set time 14
 Setup tab 24
 Shift print image..... 15
 Short status 29
 Status line..... 11, 20
 Status print 11, 30
 Status tab 22
 System messages tab 26

T

Tear-off mode 18
 Tear-off position 15
 Test grid 11, 36
 Time powersave 16
 Timezone..... 14
 Transfer print 17

U

USB flash drive..... 7, 19, 33, 48, 49
 USB slave interface 7

W

Warn level labels 17
 Warn level ribbon..... 17
 Width ASCII dump 18
 WiFi status..... 11, 34
 Windows printer setting 9
 Wireless LAN..... 19
 WLAN card 7, 10